

HEIC-Cube upstream material

张研硕

2025.03.17

Layer energy

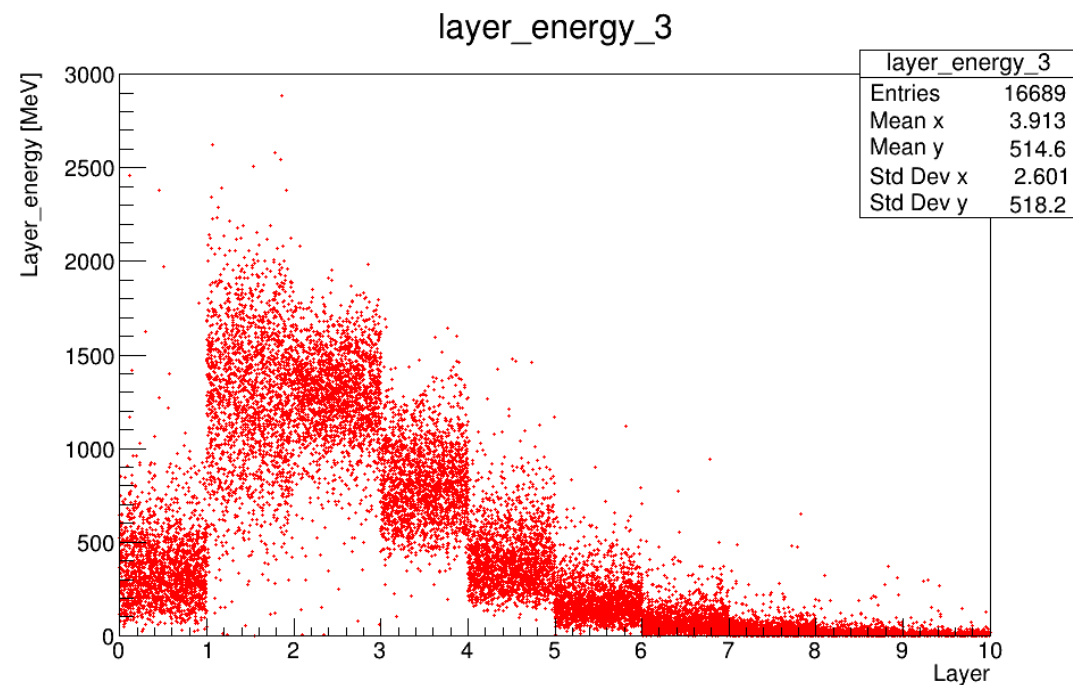
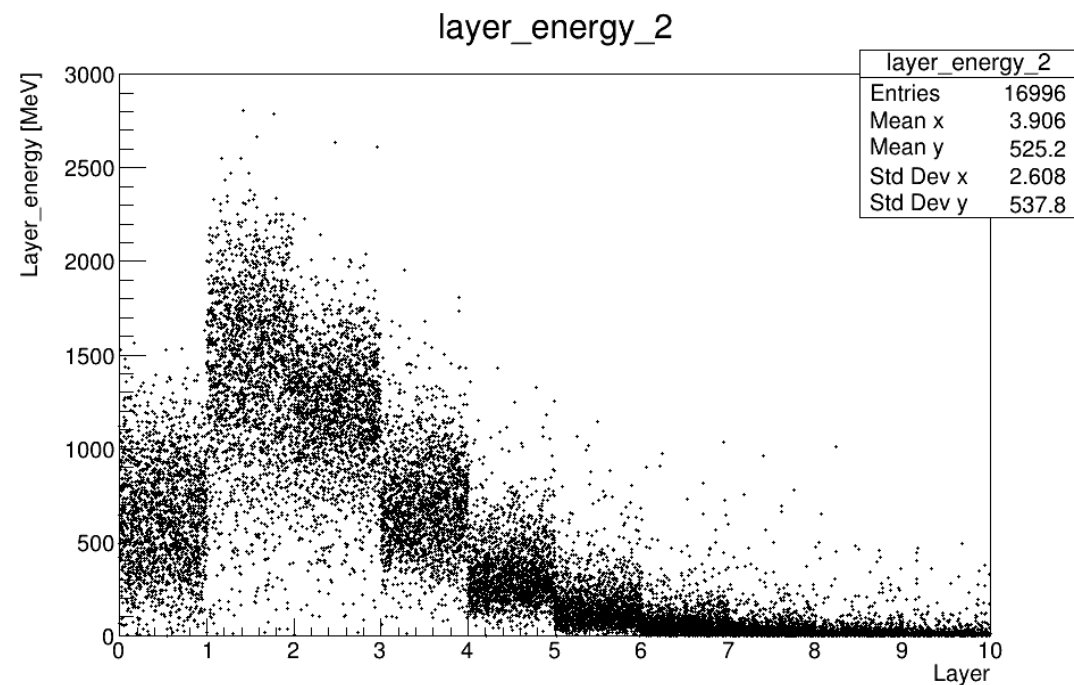

原理样机的束流测试

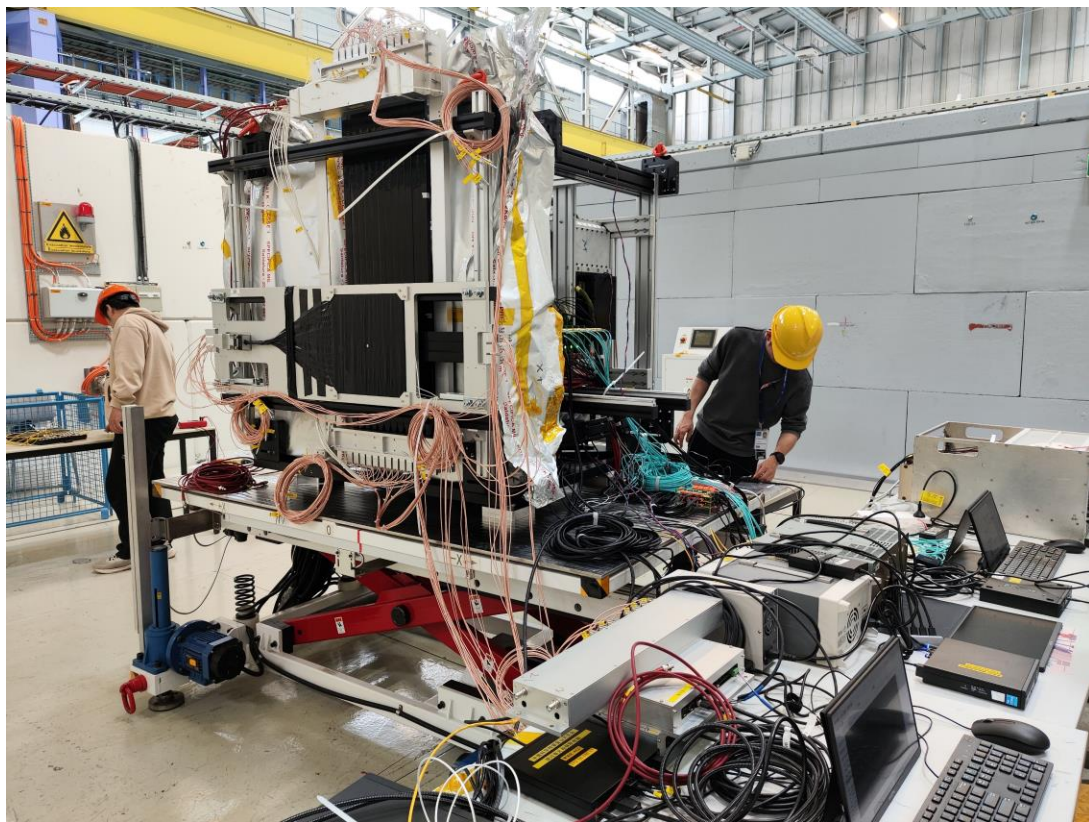

与VLAST合作组一起完成在CERN的束流测试

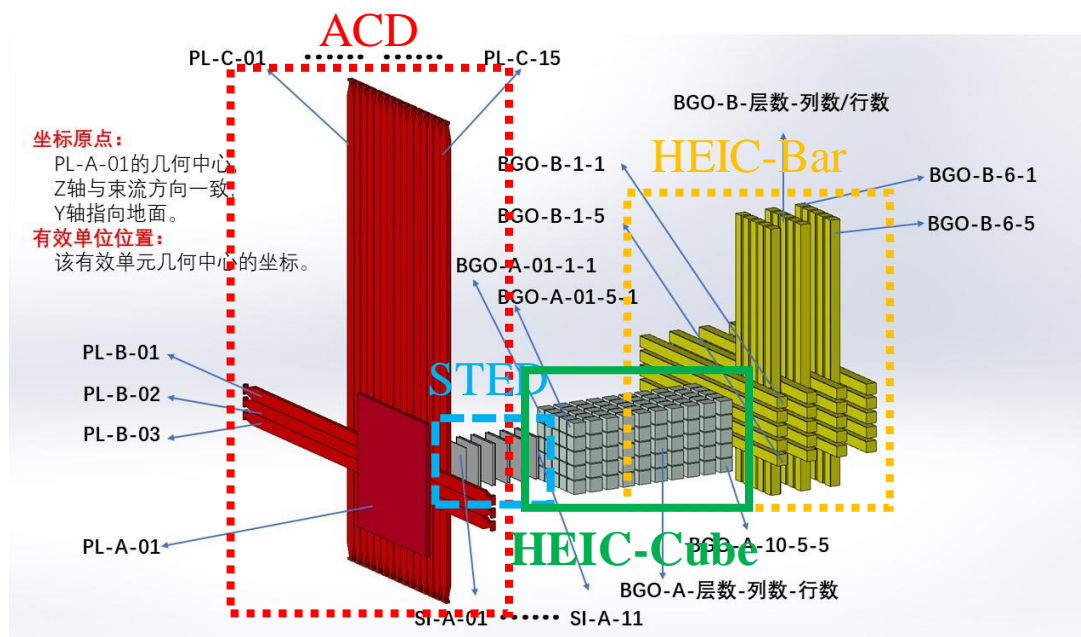

灵敏单元的位置关系

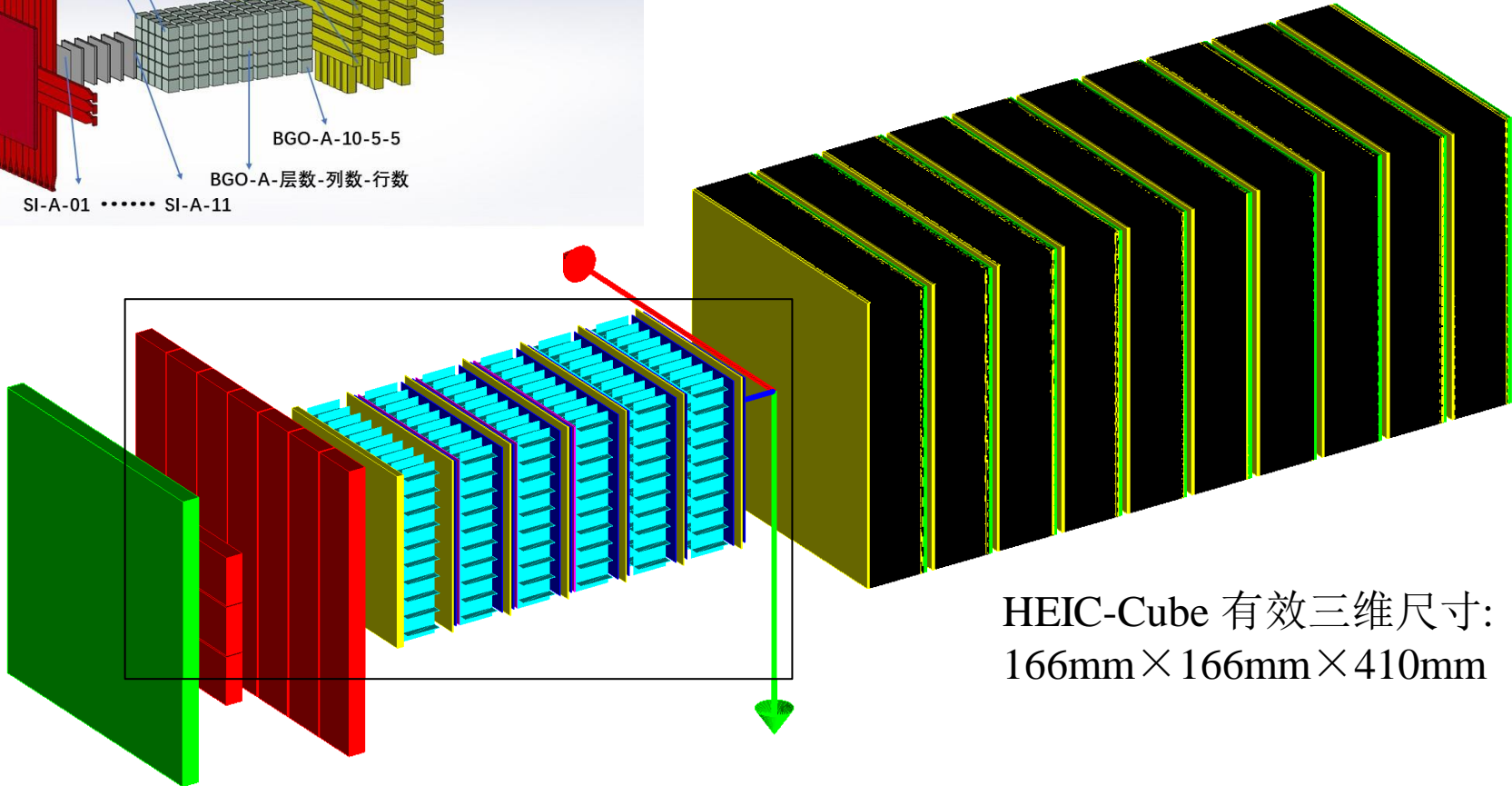
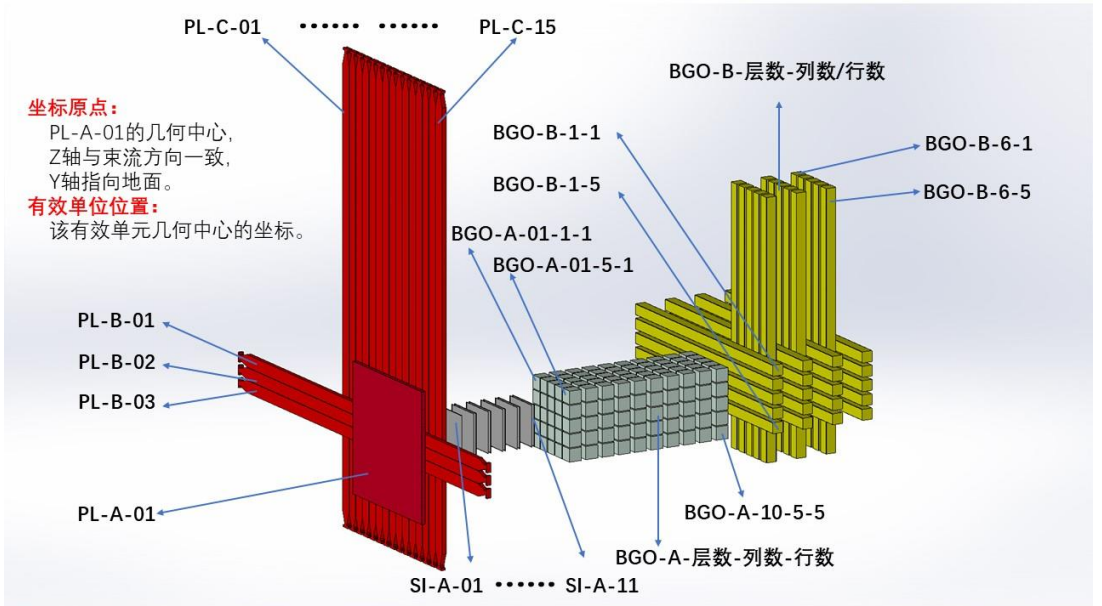

ACD structure

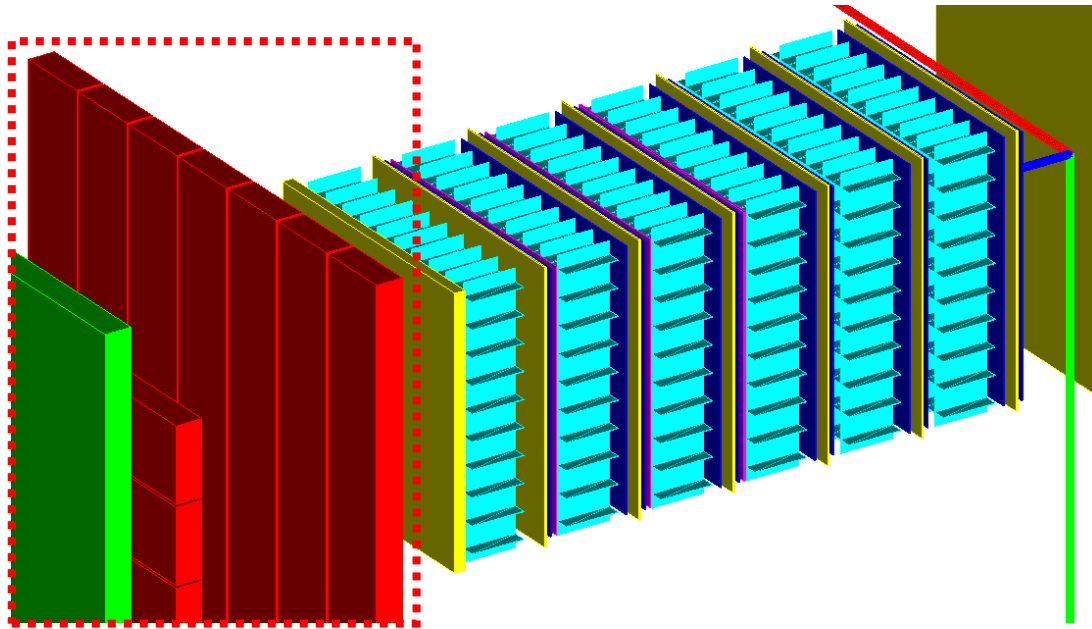

item	x size [mm]	y size [mm]	z size [mm]	color	position [mm]
plate	166	166	10	green	423.9
strip	166	28	10	red	396.4
strip	28	166	10	red	330.9

