

Introduction to Detectors

Alex Tapper

Aims and objectives

- ▶ Next term you will have a dedicated course on instrumentation from people working in this area
- ▶ This overview is intended to be enough to allow you to understand detector related issues in seminars and journal club
- ▶ There's a bias towards LHC; that's because much of the cutting edge detector R&D in past years has been in this direction, and also more specialist detector techniques for direct Dark Matter searches and neutrinos will be covered in other lectures this term
- ▶ It will be revision for many of you... I hope...

Instrumentation course

- ▶ (a) **Interaction of particles and matter** - M Pesaresi
- ▶ (b) **Electromagnetic & Hadronic Calorimetry** - P Bloch
- ▶ (c) **Semiconductor detectors and electronics** - K Uchida J Borg
- ▶ (d) **Particle ID** - M McCann
- ▶ (e) **Low level triggering and DAQ, inc FPGAs** - A Bundock, A Rose, G Auzinger
- ▶ (f) **Gas detectors** - M. Wascko

Outline

- ▶ What are the requirements for Detectors in HEP?
 - ▶ The physics requirements
 - ▶ Coping with the environment
- ▶ Particles passing through matter
- ▶ Tracking Detectors
- ▶ Calorimetry
- ▶ Muon Detection
- ▶ Detectors for triggering/timing/particle ID
- ▶ Preparing for the future - higher luminosity implications

What you want to see in a collision

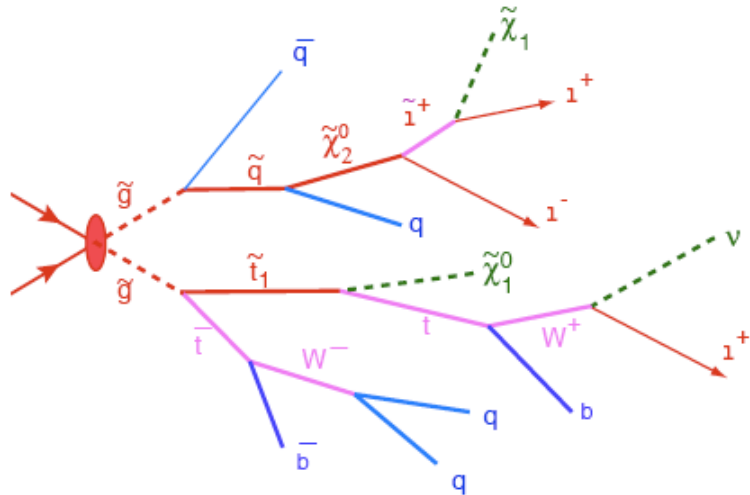

- ▶ Identify all the final decay products from the collision
 - ▶ measure their charge
 - ▶ Momentum/energy
- ▶ Reconstruct the properties of the produced particles which have decayed

What you might actually see

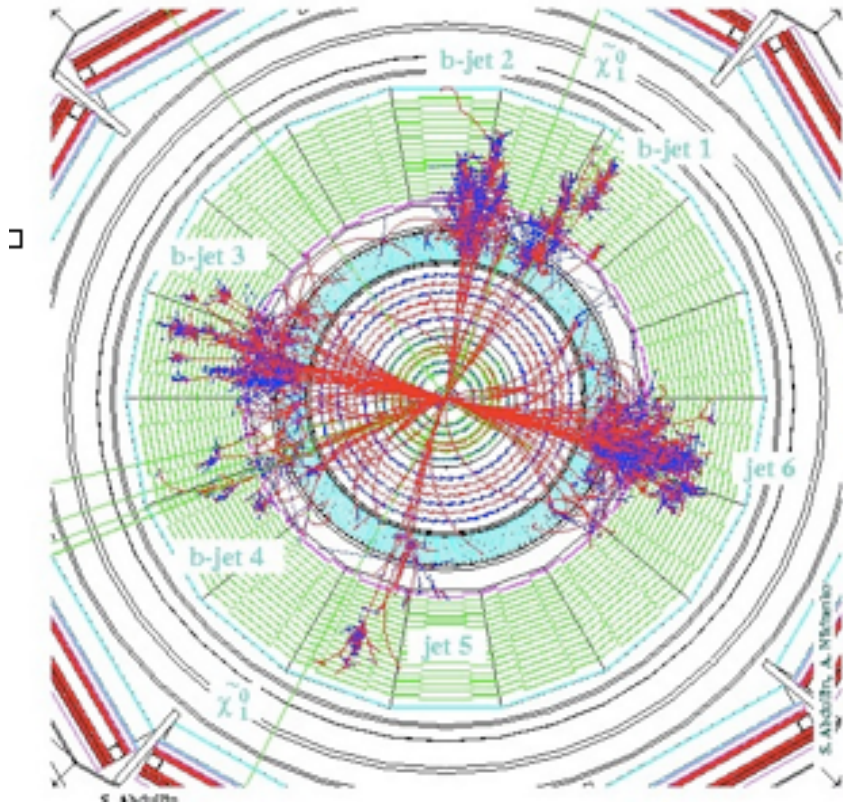

- ▶ Our main observables
 - ▶ Passage of charged particles through a tracking detector
 - ▶ Energy deposited by charged and neutral particles in a calorimetric detector
- ▶ “Missing” energy and momentum might give hints about weakly interacting particles
- ▶ Quarks appear as Jets of charged and neutral particles

Example: The LHC Environment (very challenging!)

- ▶ The LHC beams collide in each of the detectors at a rate of 40 MHz
- ▶ At design luminosity of $10^{34}\text{cm}^{-2}\text{ s}^{-2}$ There are 25 “underlying” events in every crossing of the LHC Beams
- ▶ These sit on top of the rare physics events we are looking for
- ▶ Implications for detectors
 - ▶ High radiation environment
 - ▶ High occupancy environment

Add in the LHC Environment

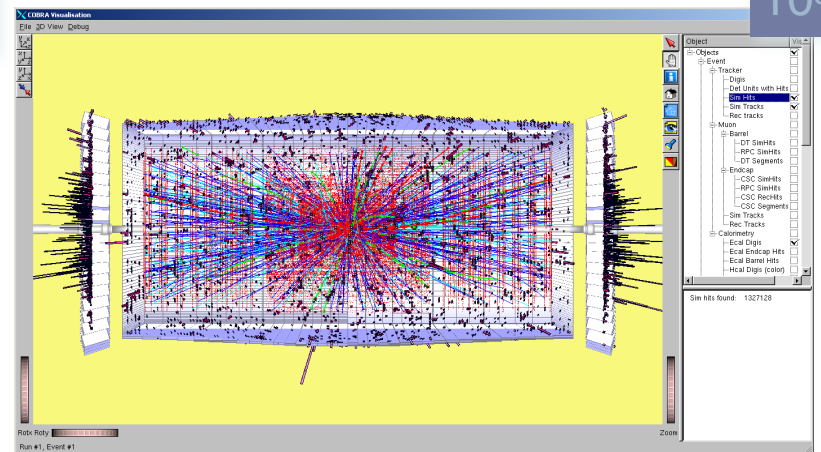
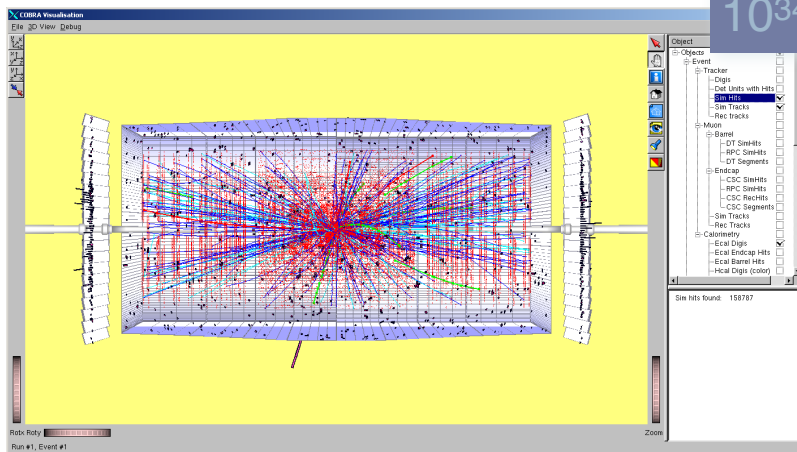
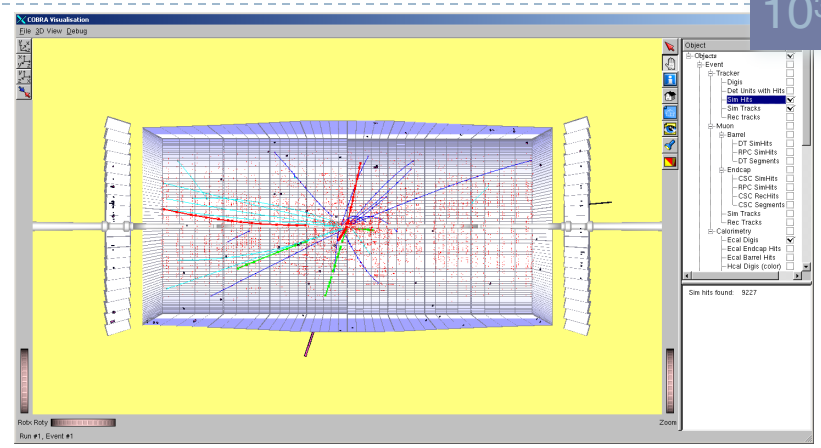
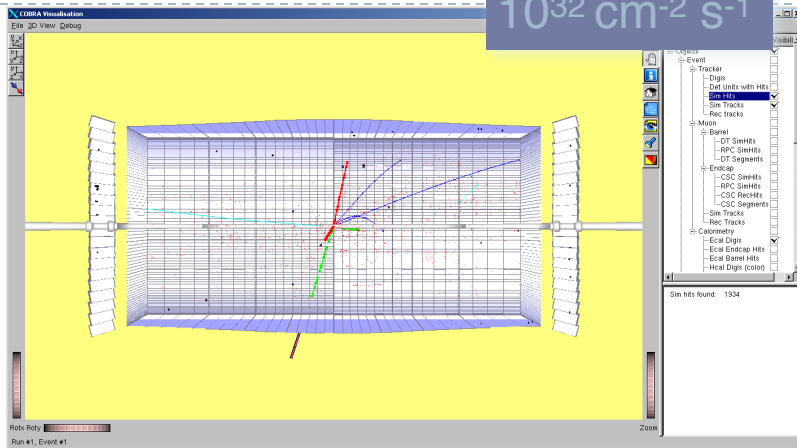

Real world detectors – certainly not massless!

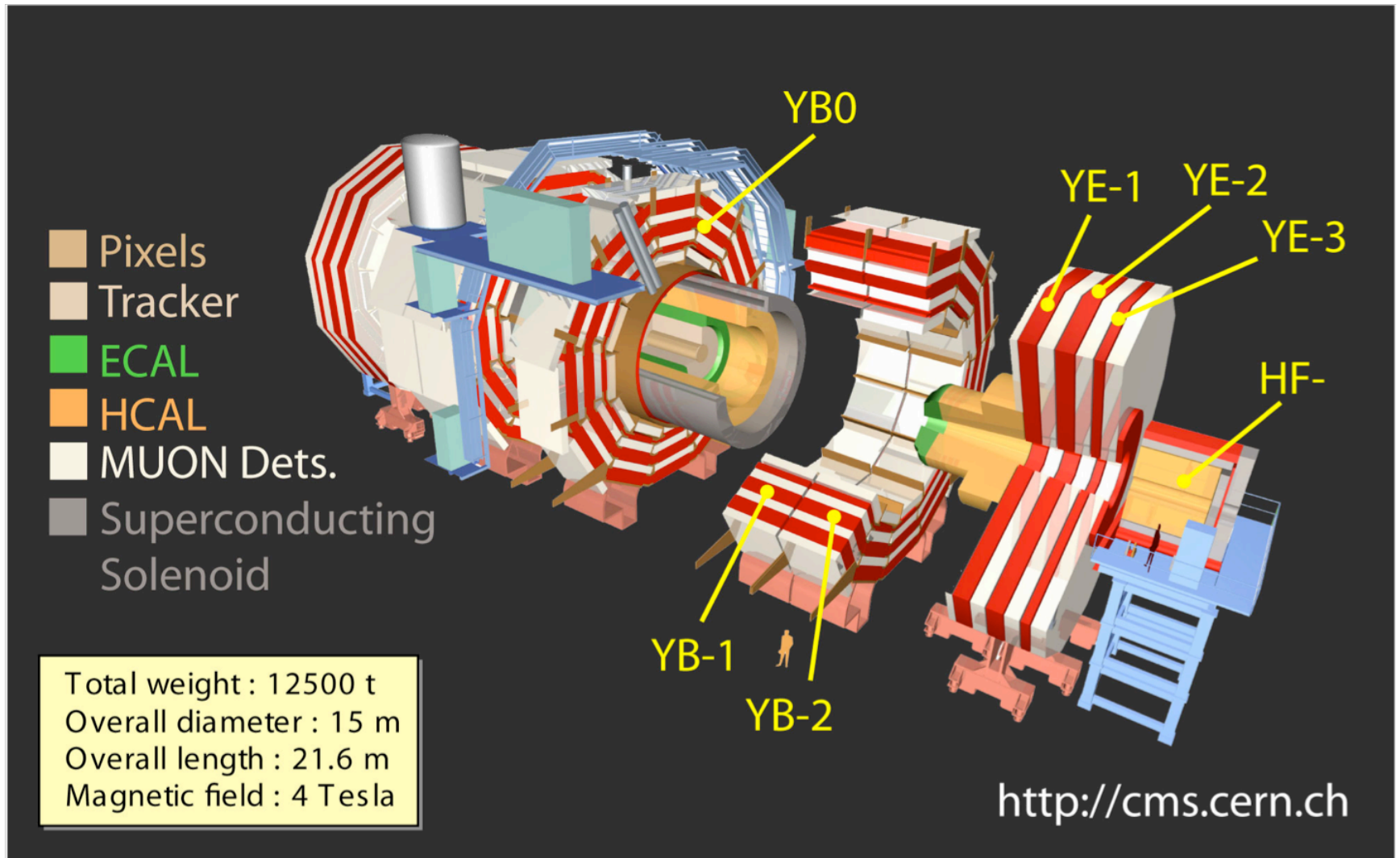

How the detectors unravel the puzzle

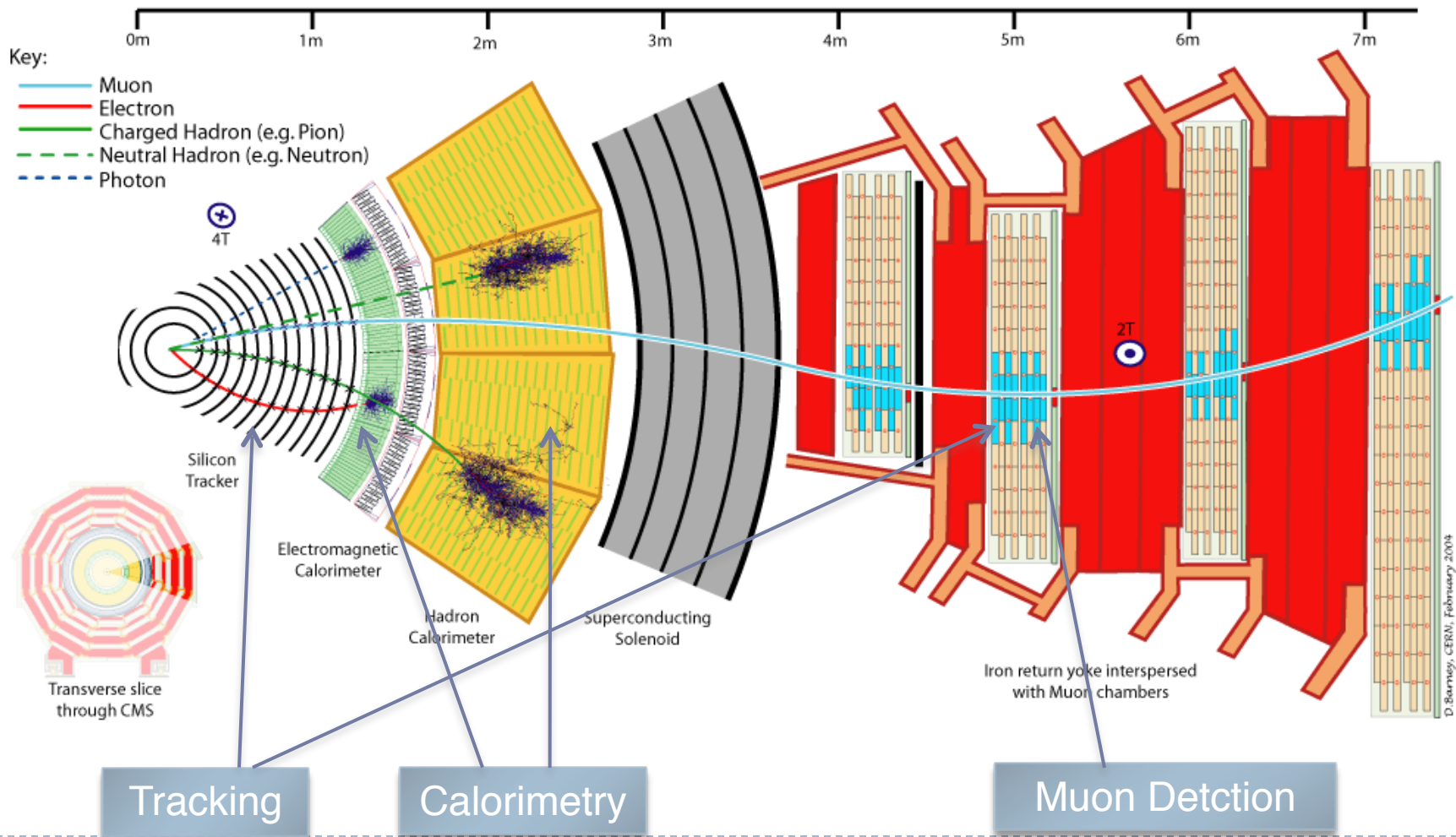

Passage of particles through our detectors

Most likely interactions which will leave signals in our detectors

| Particle | EM | Strong | Weak | None |
|--------------------------|----|--------|------|------|
| Photon | ✓ | | | |
| Electron | ✓ | | | |
| Muon | ✓ | | | |
| Charged Hadron (pion...) | ✓ | ✓ | | |
| Neutral Hadron | | ✓ | | |
| Neutrino or WIMP | | | | ✓ |

Outline

- ▶ What are the requirements for Detectors in HEP?
 - ▶ The physics requirements
 - ▶ Coping with the LHC environment
- ▶ **Particles passing through matter**
- ▶ Tracking Detectors
- ▶ Calorimetry
- ▶ Muon Detection
- ▶ Detectors for triggering/timing/particle ID
- ▶ Preparing for the future - higher luminosity implications

Passage of charged particles through matter

electron

$$F_{\perp} = \frac{ze^2}{(b^2 + x^2)} \sqrt{\frac{b}{b^2 + x^2}}$$

Impact parameter = b

x

$$\Delta p = \int_{-\infty}^{+\infty} F_{\perp} dt$$
$$= \int_{-\infty}^{+\infty} \frac{ze^2 b}{v(b^2 + x^2)^{3/2}} dx = \frac{2ze^2}{bv}$$

Charge = ze

$$\Delta E = \frac{\Delta P^2}{2m_e} = \frac{2z^2 e^4}{b^2 v^2 m_e}$$

Interaction with a Target

Target
Charge = Ze
Density = ρ
Mass = A

Charge = ze

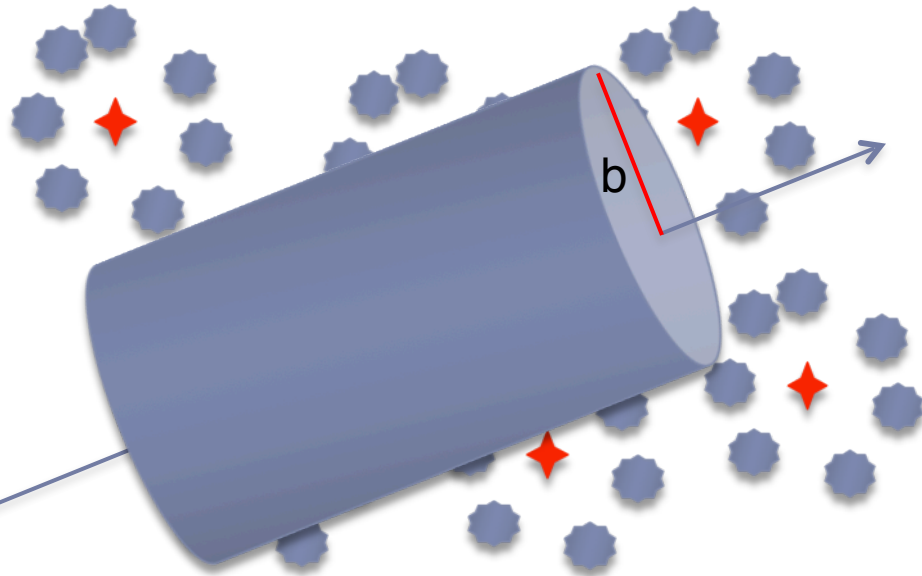

Integrate over a cylinder
surrounding the track of the particle

$$-dE = \Delta E N_e 2\pi b db dx = \frac{2z^2 e^4}{b^2 v^2 m_e} \frac{N_A \rho Z}{A} 2\pi b db dx$$

Energy Loss per unit length in material

$$\begin{aligned} -\frac{1}{\rho} \frac{dE}{dx} &= \frac{4\pi z^2 e^4 N_A Z}{v^2 m_e A} \int \frac{db}{b} = 4\pi N_A z^2 r_e^2 m_e c^2 \frac{Z}{A} \frac{1}{\beta^2} \ln \frac{b_{max}}{b_{min}} \\ &= K z^2 \frac{Z}{A} \frac{1}{\beta^2} \frac{1}{2} \ln \frac{E_{max}}{E_{min}} \end{aligned}$$

$$E_{min} = I$$

Ionization Energy

$$E_{max} = 2m_e c^2 \beta^2 \gamma^2 T_{max}$$

Head on Collision

$$r_e = \frac{e^2}{m_e c^2} \quad K = 4\pi N_A r_e^2 m_e c^2$$

Average Energy Loss in Material

Bethe-Bloch

- ▶ In the full derivation, there are additional terms for the screening effect of the intermediate material
 - ▶ The material is polarised by the electric field of the particle passing through it
- ▶ The energy loss reaches a minimum, and then rises to a plateau

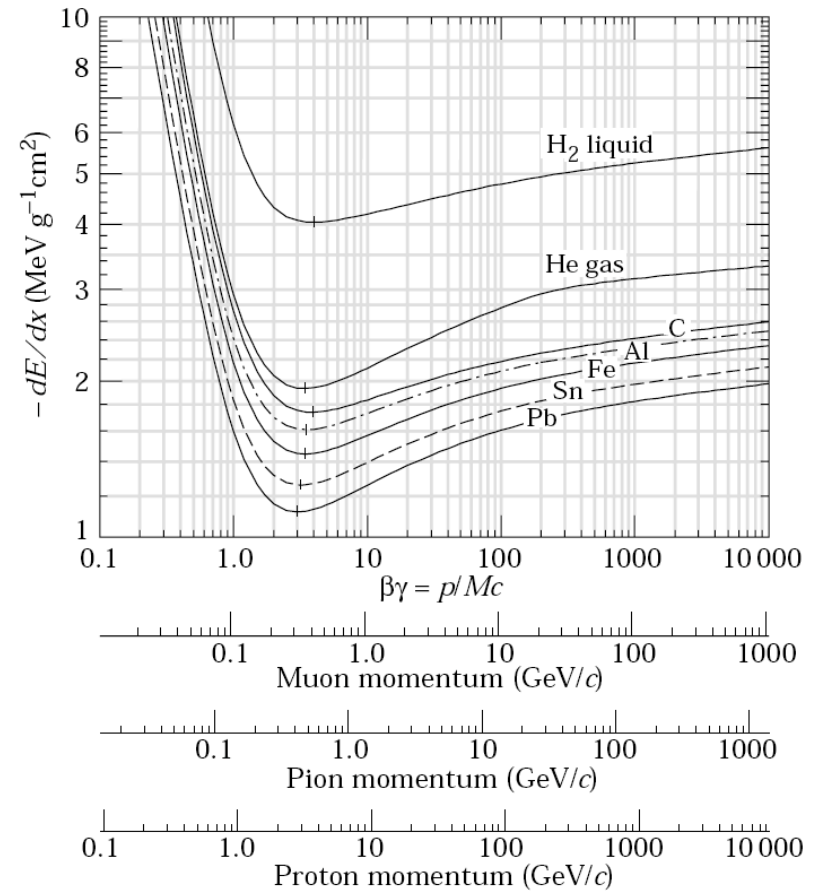

$$-\frac{dE}{dx} = K z^2 \frac{Z}{A} \frac{1}{\beta^2} \left[\frac{1}{2} \ln \frac{2m_e c^2 \beta^2 \gamma^2 T_{\max}}{I^2} - \beta^2 - \frac{\delta(\beta\gamma)}{2} \right]$$

Energy loss in a thin layer

Landau Distribution

- ▶ Calculate the distribution of energy loss that is likely to be seen in a thin layer of a detector
- ▶ The distribution and most probable energy value depend on the material composition and thickness
- ▶ There is a long tail to the distribution

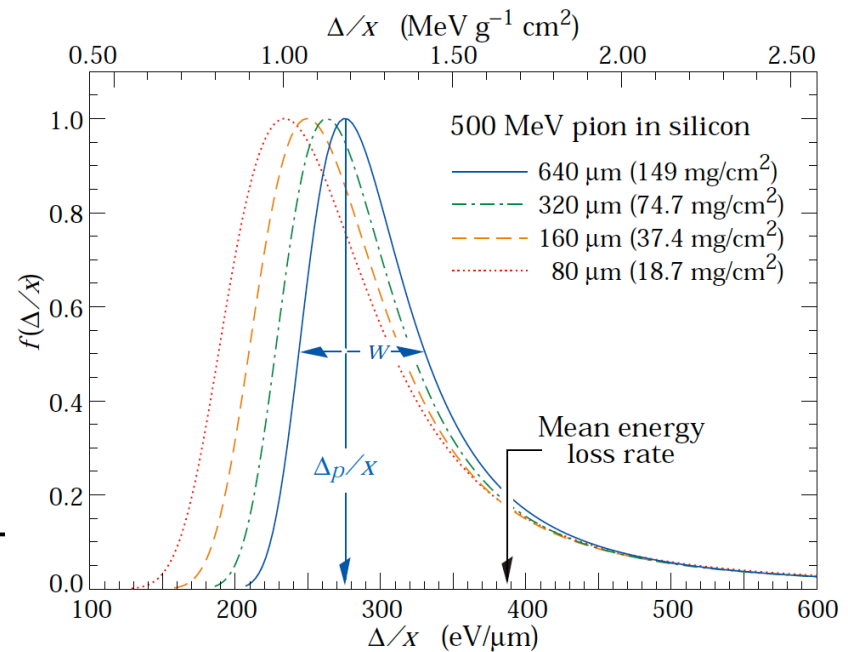

$$Q(\lambda) = \sqrt{\frac{e^{-(\lambda + e^{-\lambda})}}{2\pi}}$$

$$\lambda = A(E - E_p)$$

$E_p \equiv$ most probable energy loss

Identifying particles by energy loss

- ▶ The shape of the Bethe-Bloch curve is the same for any incoming particle on a given target, but depends on the particle velocity
- ▶ Different particle species will have different velocity for the same momentum
- ▶ Measuring both particle momentum, and dE/dx gives the possibility of an identification of different particle species
 - ▶ More effective at certain (low) momentum regions

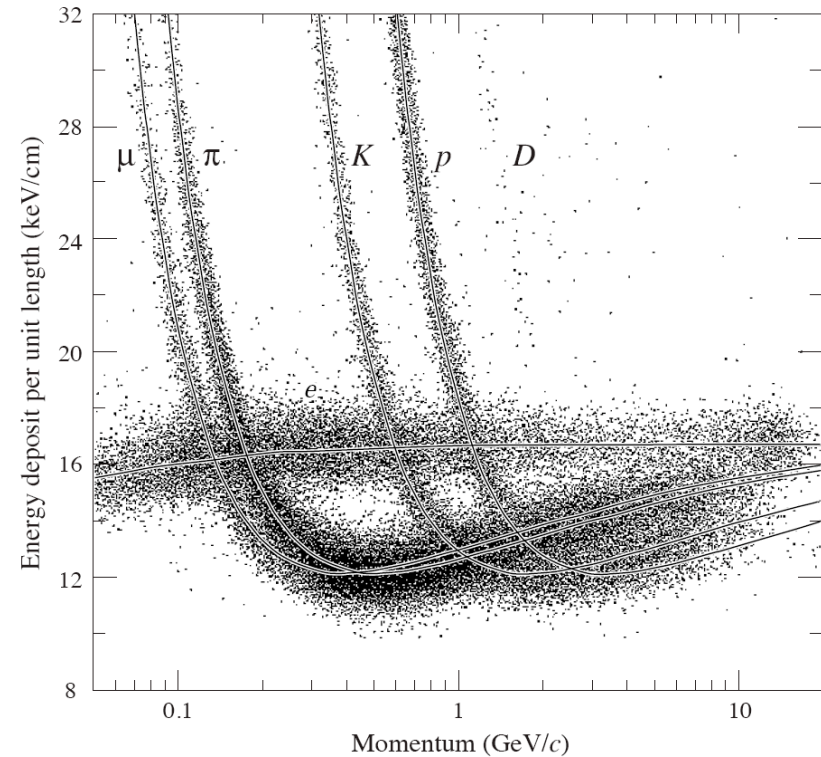

Bremsstrahlung

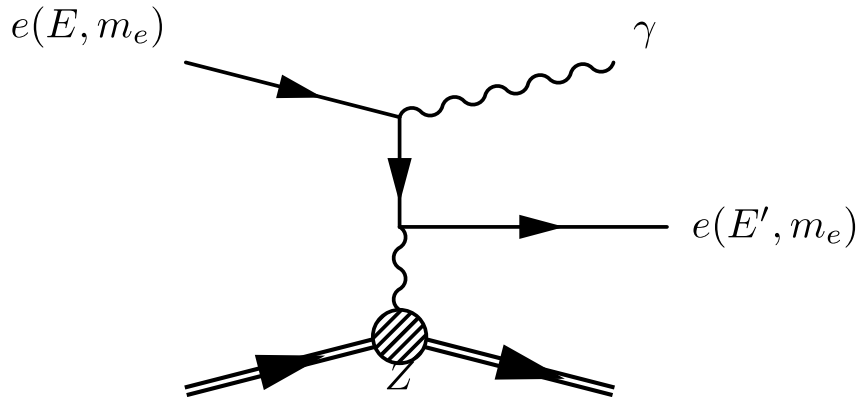

$$-\frac{dE}{dx} = \alpha N_A \frac{Z^2}{A} z^2 r^2 E \ln \frac{183}{Z^{1/3}}$$

$$-\frac{dE}{dx} = \frac{E}{X_0}$$

$$E(x) = E_0 e^{-x/X_0}$$

$$X_0 = \frac{716.4A}{Z(Z+1) \ln(287/\sqrt{Z})} \text{ [g/cm}^2\text{]}$$

- ▶ Energy loss is proportional to the energy of the incoming particle
 - ▶ Compare to Ionization which is flat in Energy
- ▶ Energy loss is proportional to $1/m^2$ of the incoming particle
 - ▶ Muons radiate much less than electrons via Bremsstrahlung
- ▶ X_0 is the Radiation length which is a characteristic of the material
 - ▶ The incoming particle energy will decrease to $E_0 e^{-1}$ after travelling through one X_0 of material.

$$r = \frac{e^2}{mc^2}$$

Muon Energy Loss

Dominated by Ionization losses at the energies of interest for LHC detectors

Ionization loss for muons is relatively constant for a given material at these energies

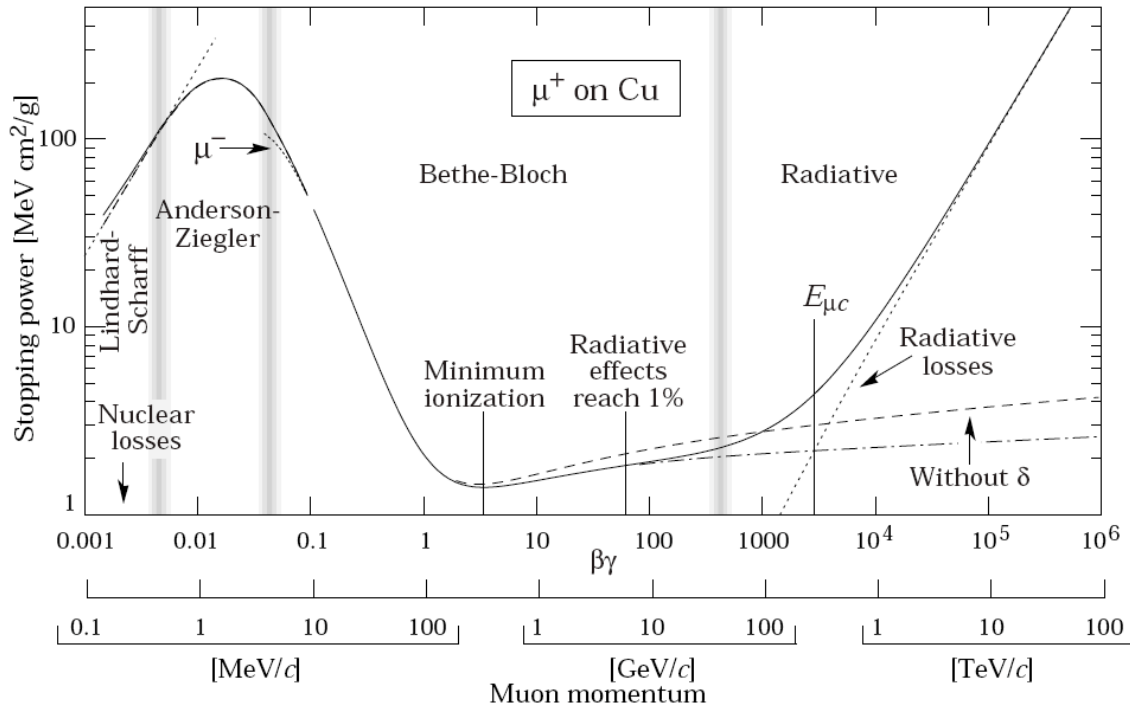

Electron energy loss

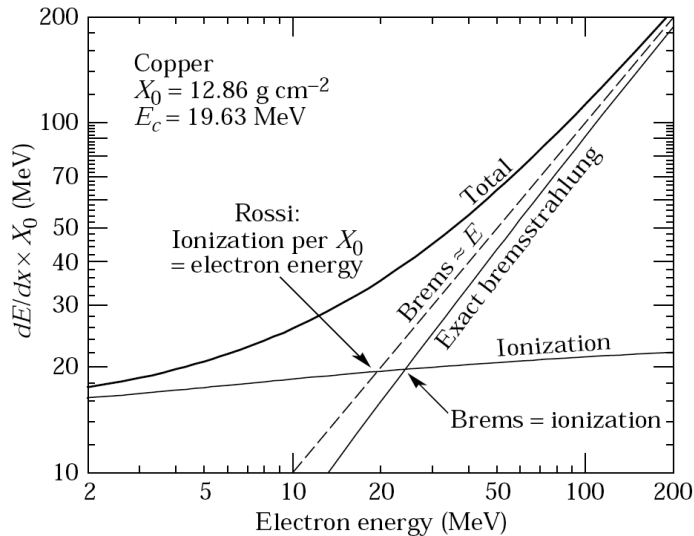
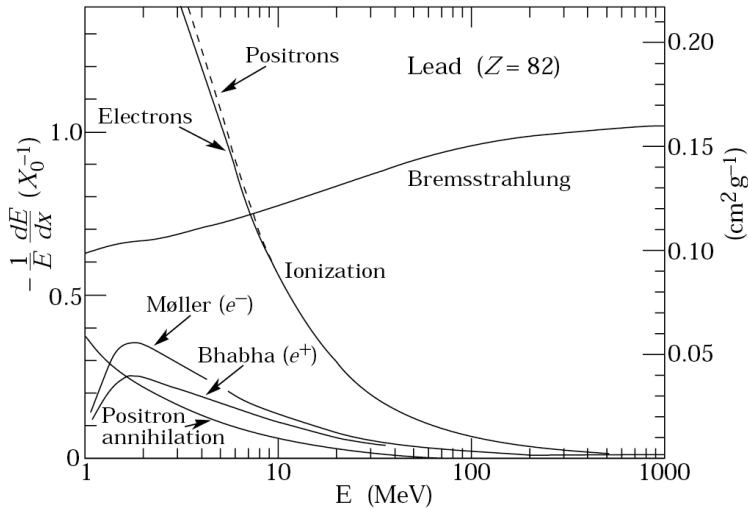

- ▶ Bremsstrahlung is the main mechanism for electron energy loss at energies above about 10 MeV
- ▶ (Compare 400 GeV for Muons)
- ▶ Critical Energy
- ▶ Where the ionization loss equals the loss from Bremsstrahlung

Photon Energy Loss

- ▶ For Photons, pair creation in the field of the nucleus is the dominant mechanism for energy loss at energies above an MeV.
- ▶ Compton scattering, then Rayleigh (and finally the photo-electric effect) dominate at lower energies

$$\sigma_{pair-creation} = \frac{7}{9} \frac{A}{N_A} \frac{1}{X_0}$$

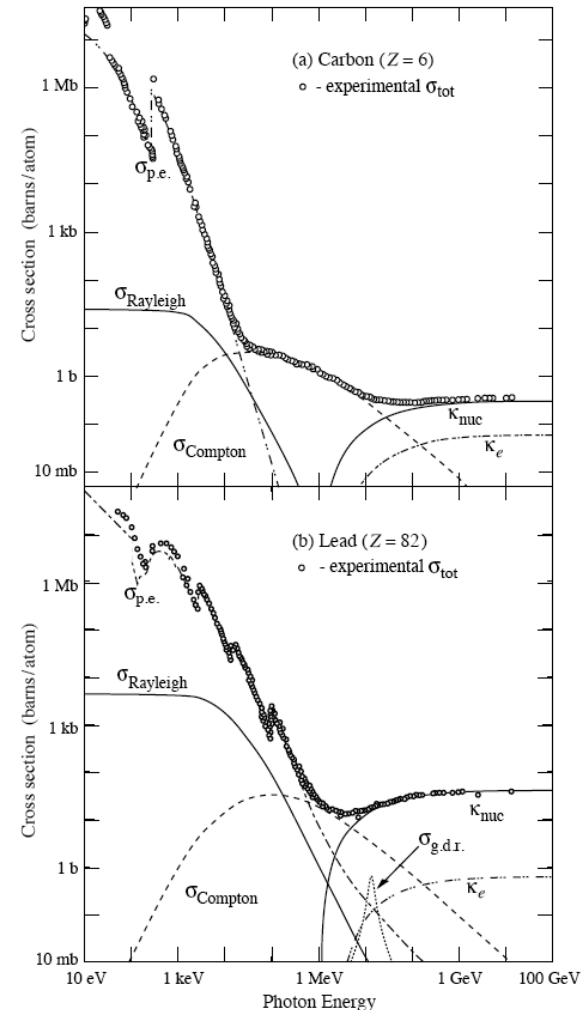

Electromagnetic Showers

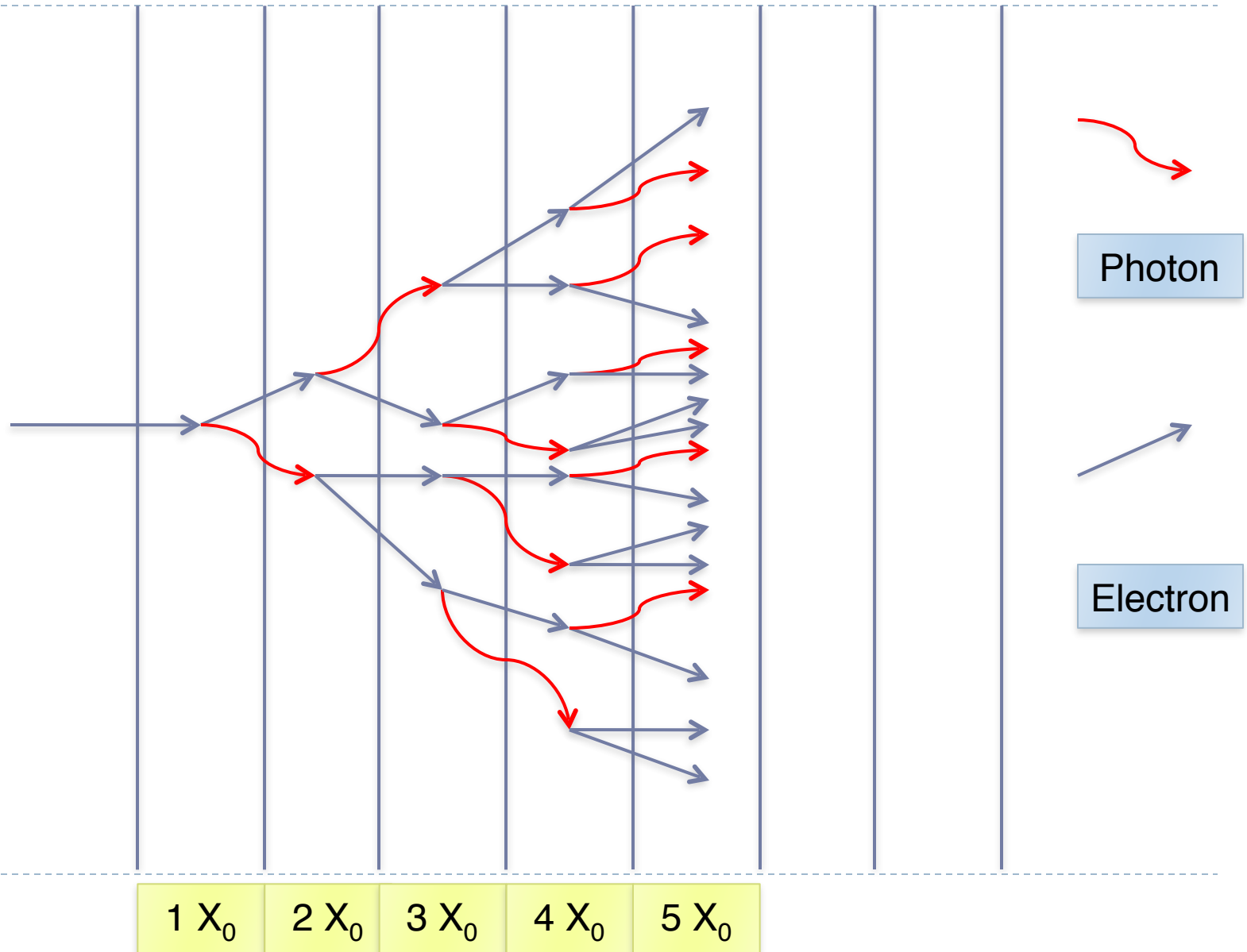

Electromagnetic Shower development

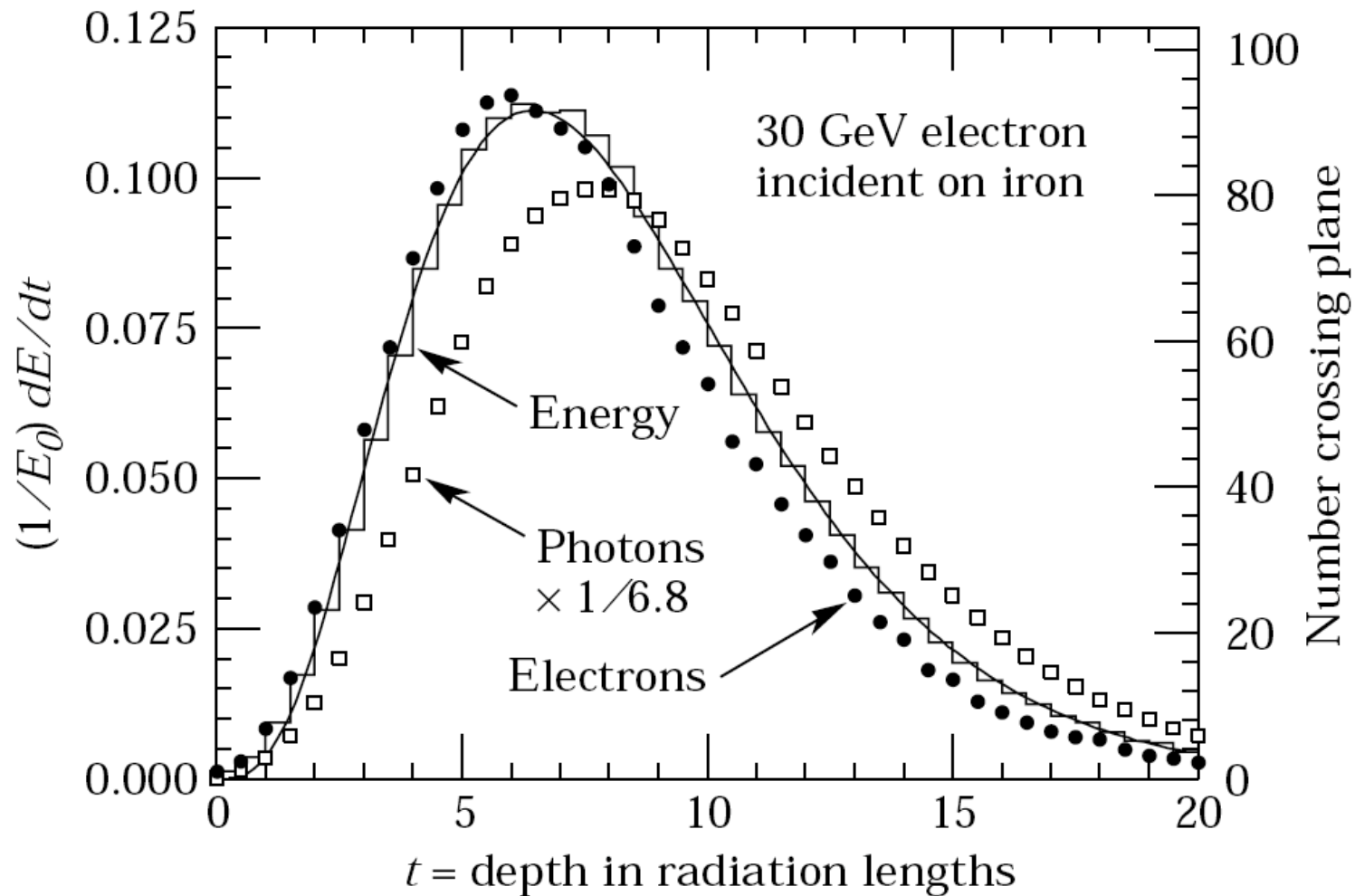

Outline

- ▶ What are the requirements for Detectors for HEP?
 - ▶ The physics requirements
 - ▶ Coping with the environment
- ▶ Particles passing through matter
- ▶ **Tracking Detectors**
- ▶ Calorimetry
- ▶ Muon Detection
- ▶ Detectors for triggering/timing/particle ID
- ▶ Preparing for the future - higher luminosity implications

Basics of Tracking

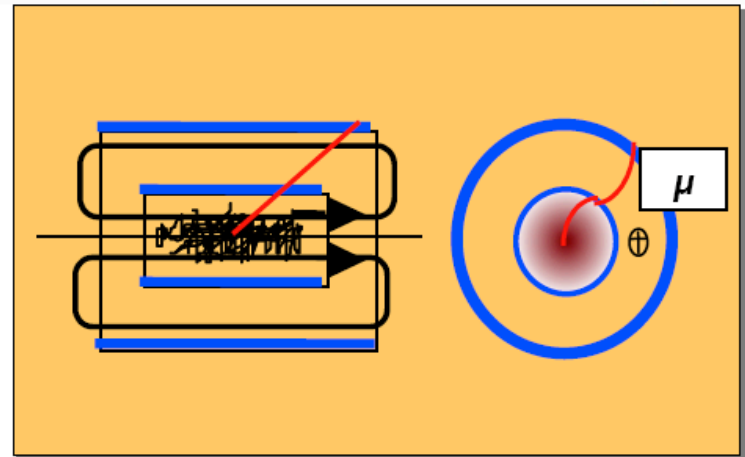
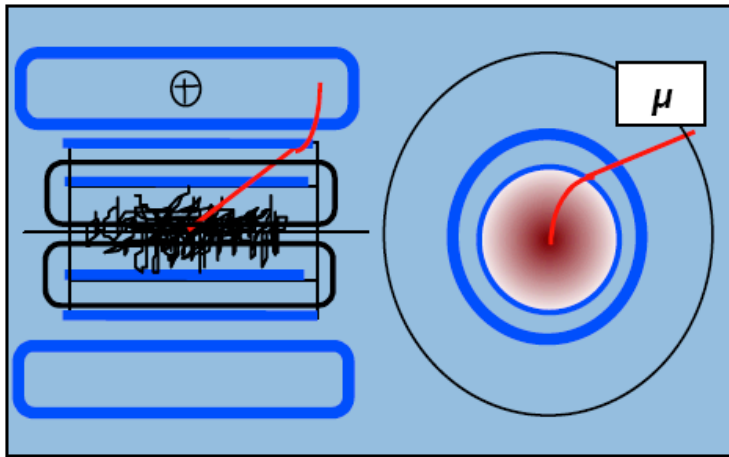
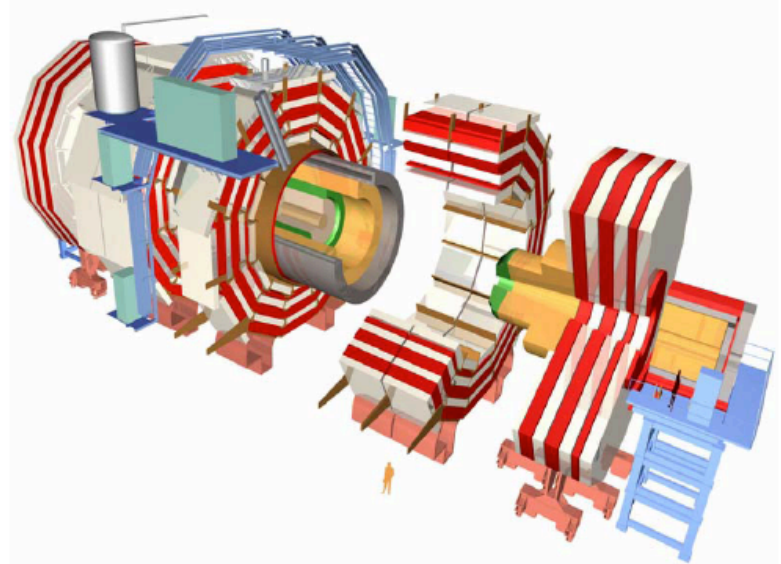
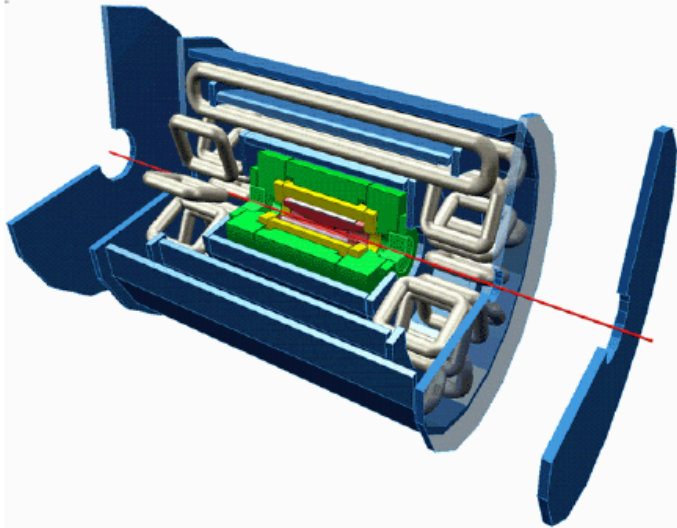

Finding and measuring charged particle properties

- ▶ Physics events at the LHC are full of a large number of charged particles.
- ▶ These pass through our detectors interacting with the detector material
- ▶ We want to
 - ▶ Measure the ionization from passing particles
 - ▶ Associate these “hits” with individual particles
 - ▶ Measure the trajectory of the particles
 - ▶ Gives us the momentum/charge

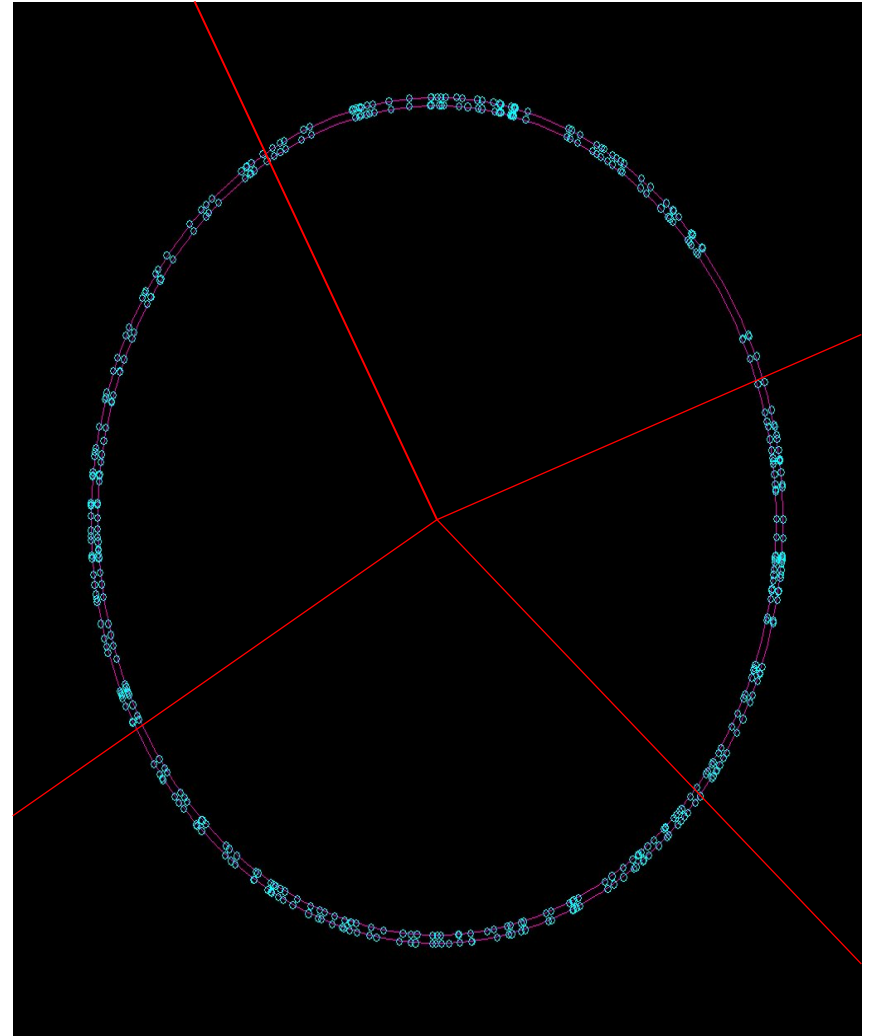

Tracking 101

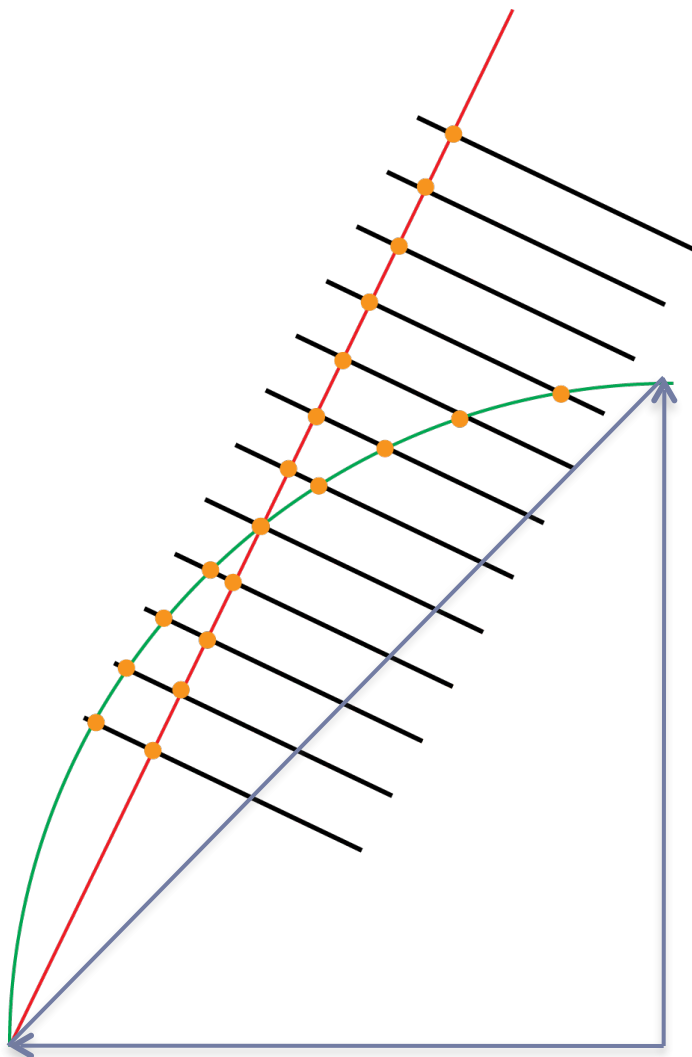

- ▶ Particles in a uniform magnetic field move in a circle
- ▶ The radius of the circle is proportional to the magnetic field
 - ▶ We fit the measured points to a helix to determine the momentum and point of origin
 - ▶ There is a global momentum determined for the track
- ▶ Limit at high momentum depends on how well we can measure the sagitta
 - ▶ Low momentum should in principle continue to give better and better measurements of the track momentum
- ▶ We can also mis-measure tracks by not associating the correct hits to a given particle
 - ▶ *Pattern recognition* at the LHC is vital

$$p[GeV/c] = 0.3 R[m] B[T]$$

Multiple scattering

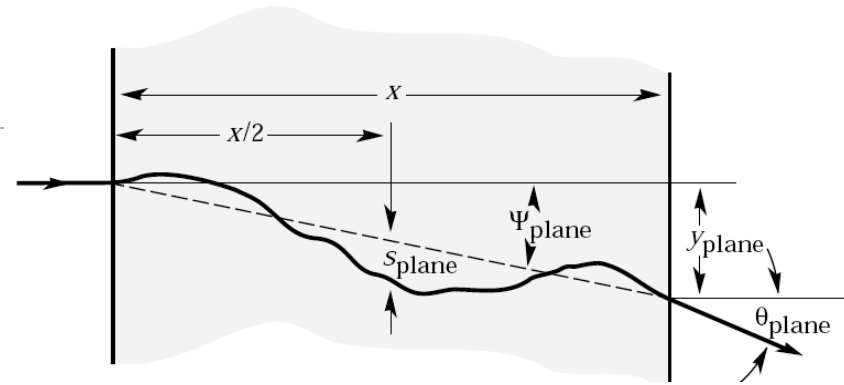

- ▶ Particles undergo multiple interactions as they pass through tracking detector material (and air or other material)
 - ▶ A bigger effect for lower momentum tracks
 - ▶ Multiple scattering limits resolution at low p
 - ▶ Tracks no longer follow a Helix
- ▶ Probability that after passing through a thickness x of a material with radiation length X_0 a particle is deflected by an angle θ is a gaussian distribution with sigma

$$\Theta_0 = \frac{0.0136}{\beta c p [\text{GeV}/c]} Z \sqrt{\frac{x}{X_0}}$$

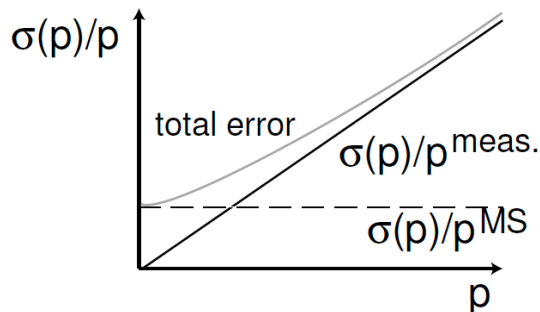
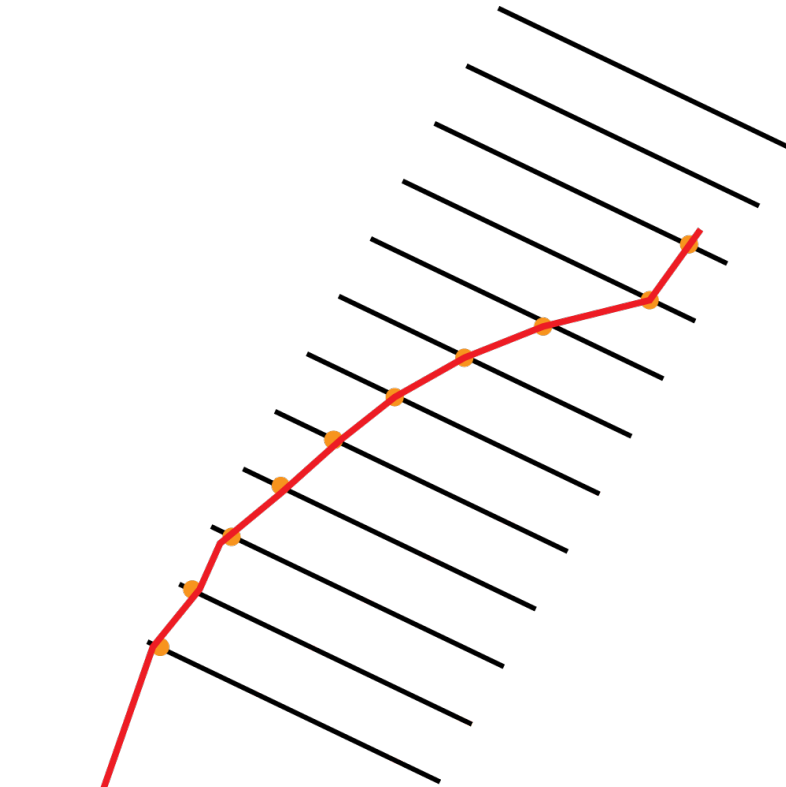

Kalman filter fitting of tracks

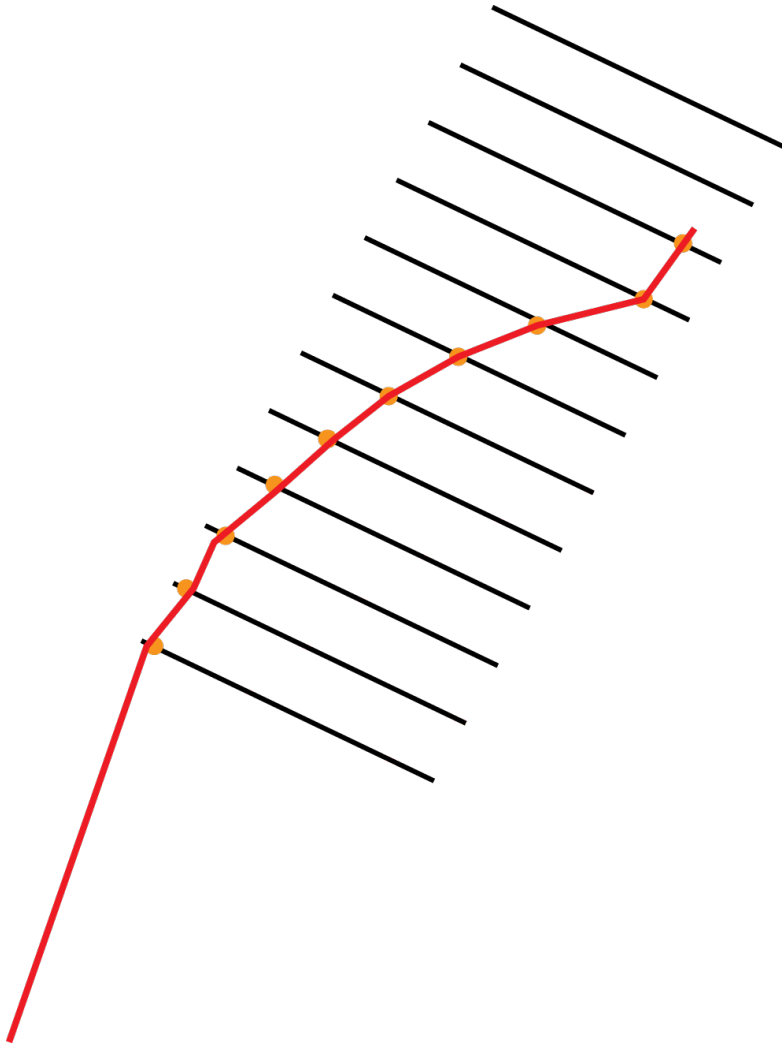

- ▶ In order to account for the effects of multiple scattering we need to modify our algorithms to allow for track deflection at each passage through material
- ▶ Tracks are propagated through material correcting for loss of momentum
 - ▶ The track momentum varies as a function of where it is measured
 - ▶ We need a good model of the material in the detector
 - ▶ There can be pattern recognition problems when there are large deflections in a track

Properties of tracking devices

- ▶ Ideally we want to measure the passage of each charged track as accurately as possible
 - ▶ Better spatial resolution on hits helps us to separate the hits from closely spaced particles (pattern recognition)
 - ▶ We don't get a map to associate hits to particles, we have to figure it out...
 - ▶ Better measurement of the positions can give us a better precision on momentum resolution
 - ▶ There is a big premium on having extremely good spatial resolution very close to the interaction point of the beams
 - Separate underlying events which come from different locations in the beam spot
 - Look for long lived particles which decay of order mm from the primary interaction point
- ▶ However (think Heisenberg) we can't measure the particles coming out without disturbing them
 - ▶ Interaction in material in the detectors can cause particles to lose energy
 - ▶ Remember photons, electrons very sensitive to small amounts of material
 - ▶ So ideally we want a zero mass infinite precision device for a detector

Covering the inner volume with tracking detectors - ATLAS

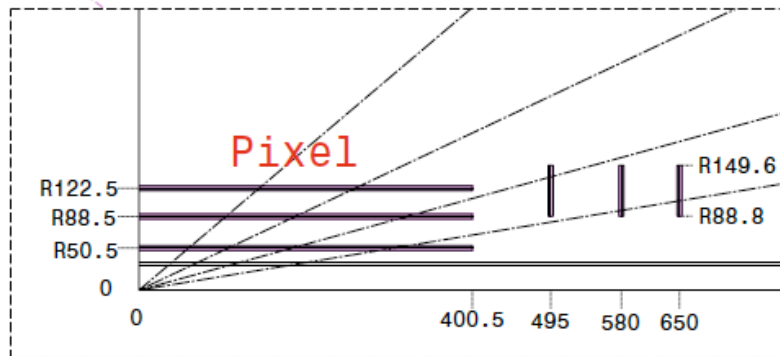
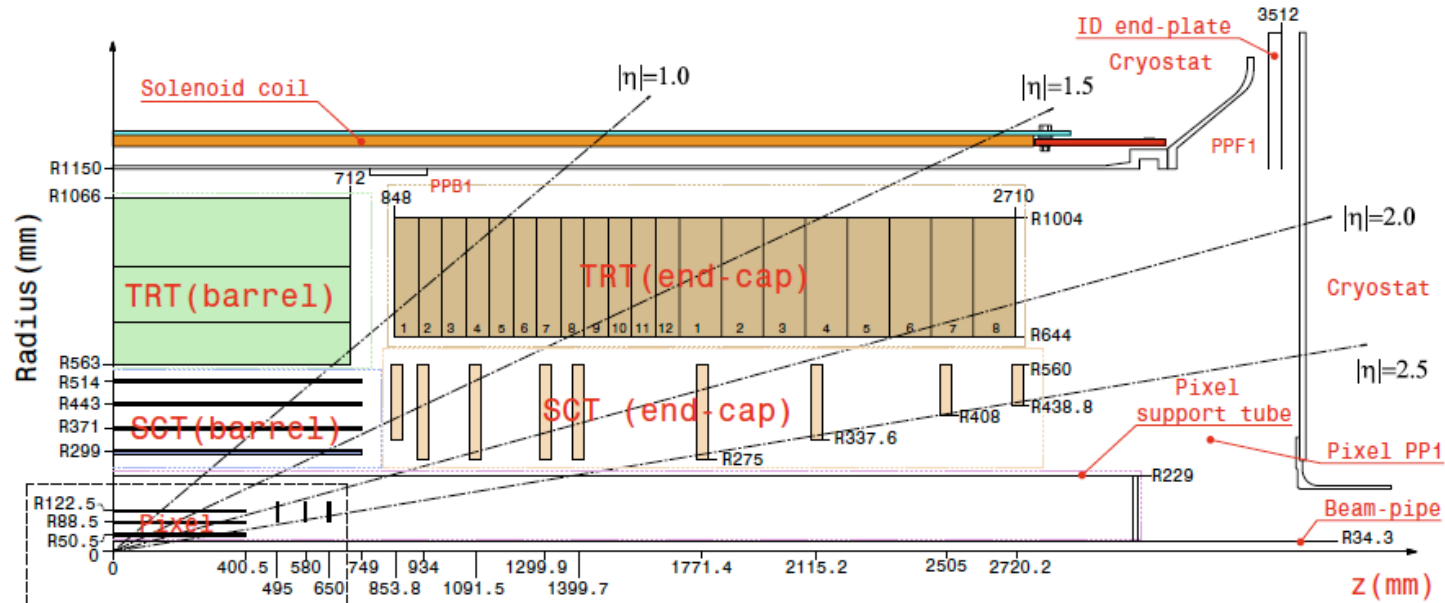

Envelopes

| | | |
|-------------|-------|------------------------------------------|
| Pixel | ----- | 45.5 < R < 242 mm z < 3092 mm |
| SCT barrel | ----- | 255 < R < 549 mm z < 805 mm |
| SCT end-cap | ----- | 251 < R < 610 mm 810 < z < 2797 mm |
| TRT barrel | ----- | 554 < R < 1082 mm z < 780 mm |
| TRT end-cap | ----- | 617 < R < 1106 mm 827 < z < 2744 mm |

CMS Tracker

- ▶ All Silicon tracker
 - ▶ 200 m² of Silicon detectors
 - ▶ 50 Kw of power
 - ▶ 10,000,000 Channels strips
 - ▶ 60,000,000 Channels Pixels
- ▶ Cylindrical Barrels at low pseudo-rapidity
- ▶ Circular Disk Endcaps at higher pseudo-rapidity

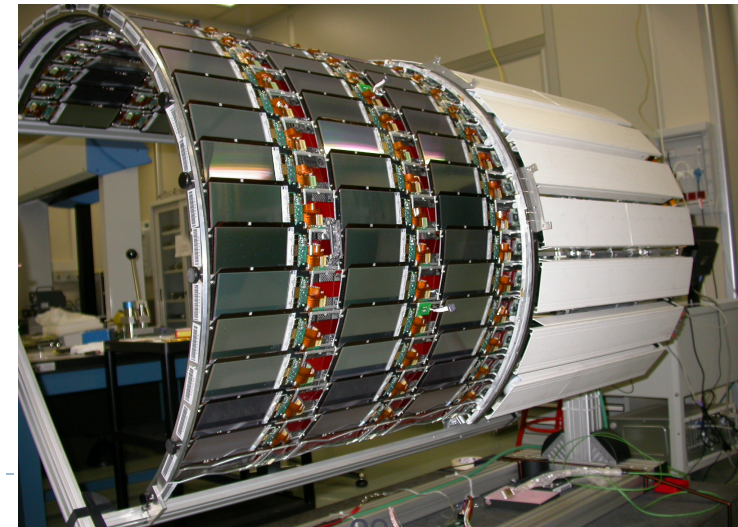
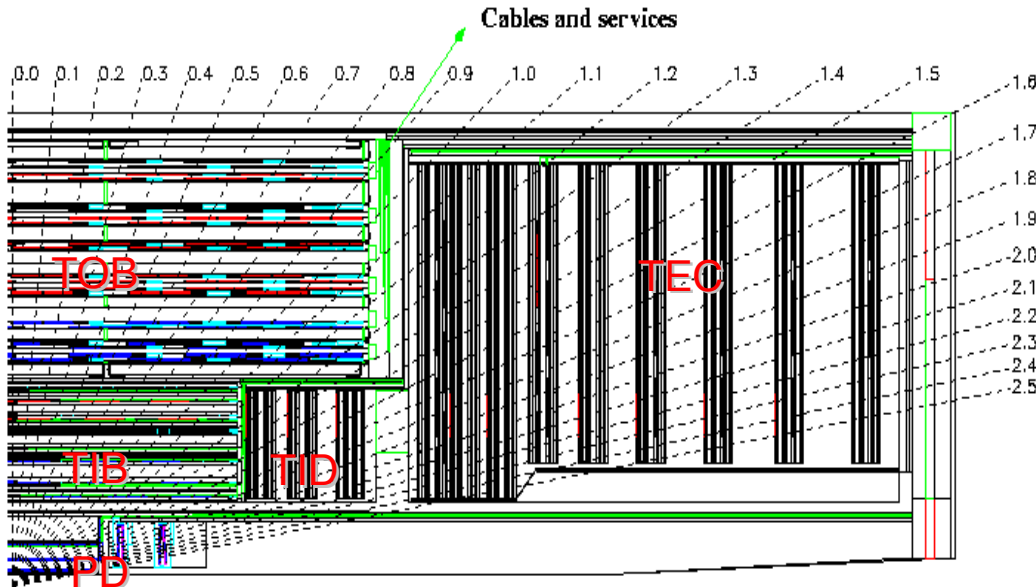
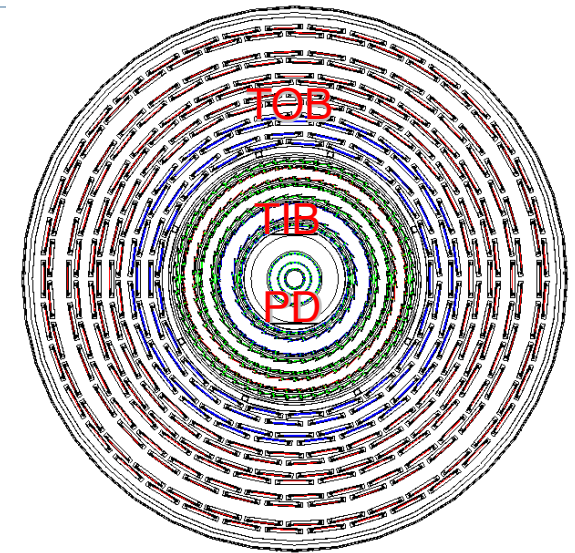

The innermost layers “Pixel” detectors

- ▶ Want smallest amount of material
- ▶ Highest density of channels
- ▶ 3D space points
- ▶ Able to withstand the high radiation environment close to the beam
- ▶ Silicon Pixel detectors are the choice
 - ▶ Localize each ionization signal to a small region
 - ▶ ($\sim 150\mu\text{m} \times 150\mu\text{m}$)
 - ▶ Small amount of material
 - ▶ Fast readout
 - ▶ Typically of order 60 M Pixels
 - ▶ but with 40MHz readout capability

How does a silicon detector work?

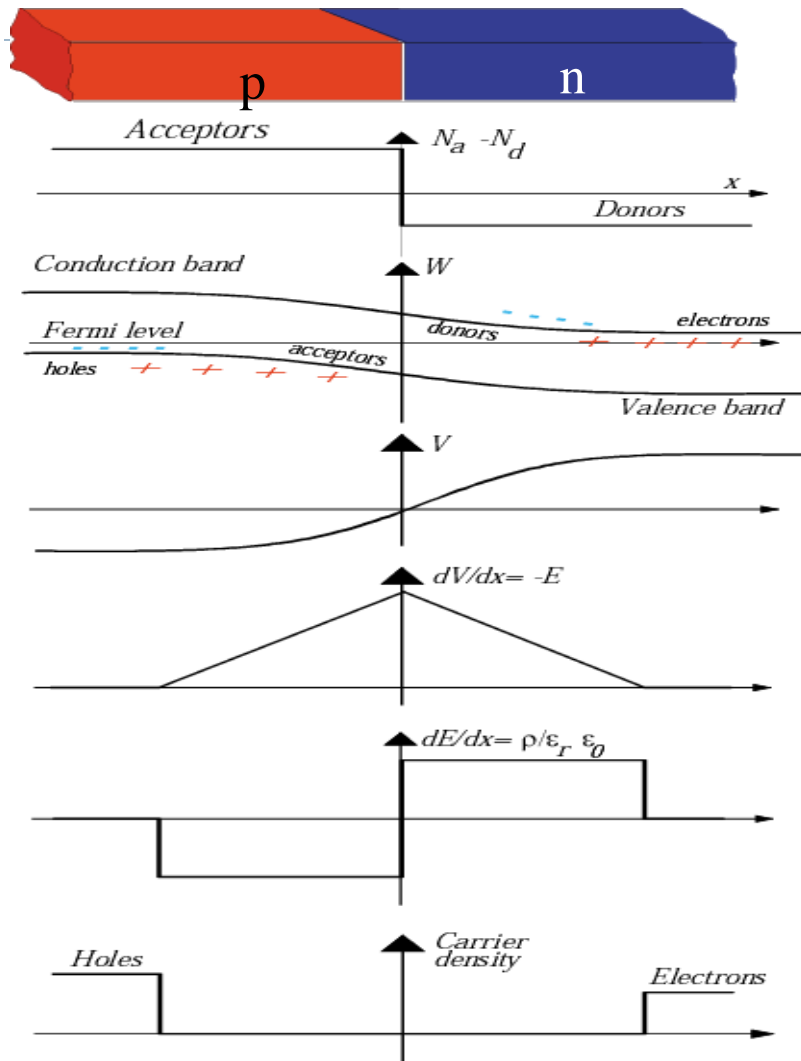

- ▶ Silicon is doped to create
 - ▶ Arsenic -N-type (more electrons)
 - ▶ Boron - P-type (more holes)
- ▶ A Diode is constructed by bringing together N-P material creating a junction
- ▶ At the junction there is a region with no charge carriers –
 - ▶ This is the depletion region

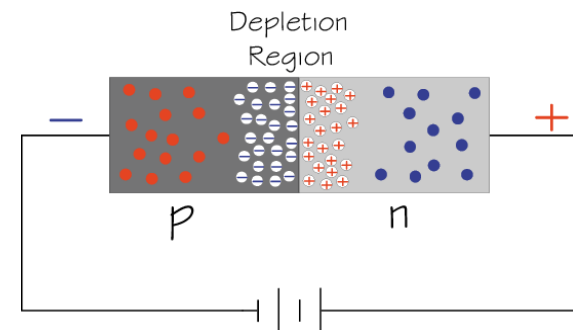

- Electron
- ⊕ Positive ion from removal of electron in n-type impurity
- ⊖ Negative ion from filling in p-type vacancy
- Hole

Charged particles in Silicon detectors

- ▶ A reverse bias is applied to the diode which extends the depleted region
- ▶ When a charged particle passes through a silicon diode, many electron-hole pairs are created in the depleted region
 - ▶ Silicon is dense
 - ▶ Energy loss 3.8 MeV/cm
 - ▶ The energy to create an e-h pair is much lower than the ionization energy
 - ▶ 3.6 eV compared to 10's of eV for ionization
 - ▶ ~9000 e- created in each 100 μm thickness of Silicon
- ▶ The electrons drift in the electric field to the end of the detector where they create a signal which can be read out
 - ▶ Charge sharing between neighboring pixels or strips allows us to achieve a better single hit position resolution

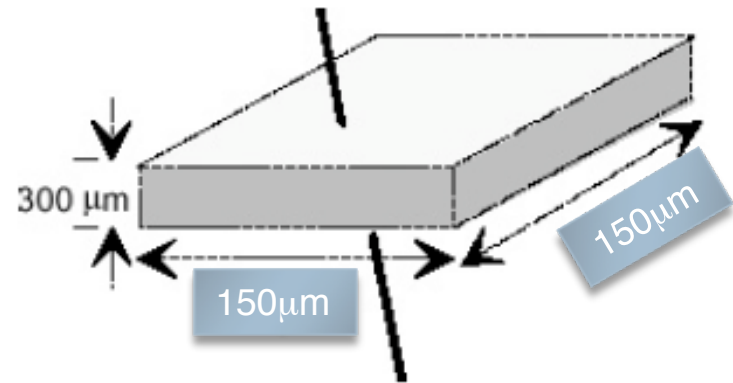
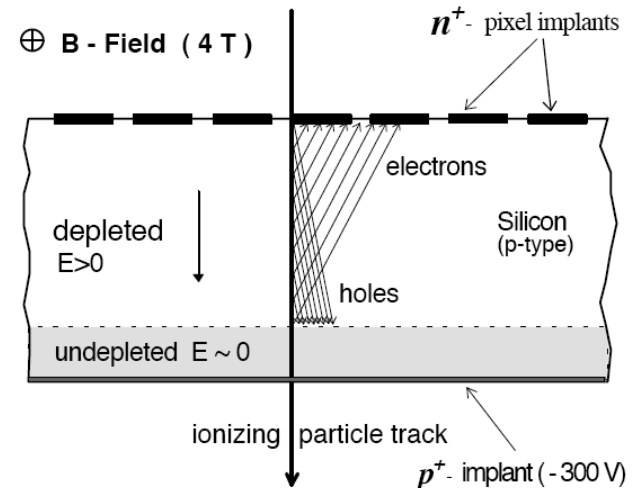

Typical Pixel

Readout of Pixel detectors

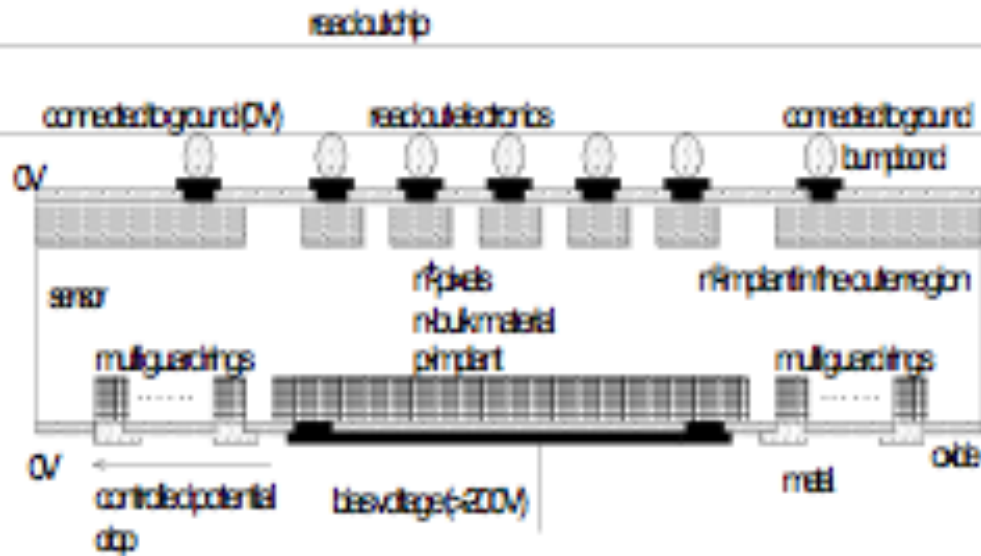

- ▶ One of the big difficulties is each how to read out each individual pixel
 - ▶ Large number of electronics channels (~60M)
 - ▶ Want to uniformly cover the surface area with sensitive detector
 - ▶ Difficult connectivity problem
- ▶ Electronics is bonded directly to the back of the Silicon Sensor
 - ▶ Channels are then read out in columns
 - ▶ End of the columns connected to external readout system

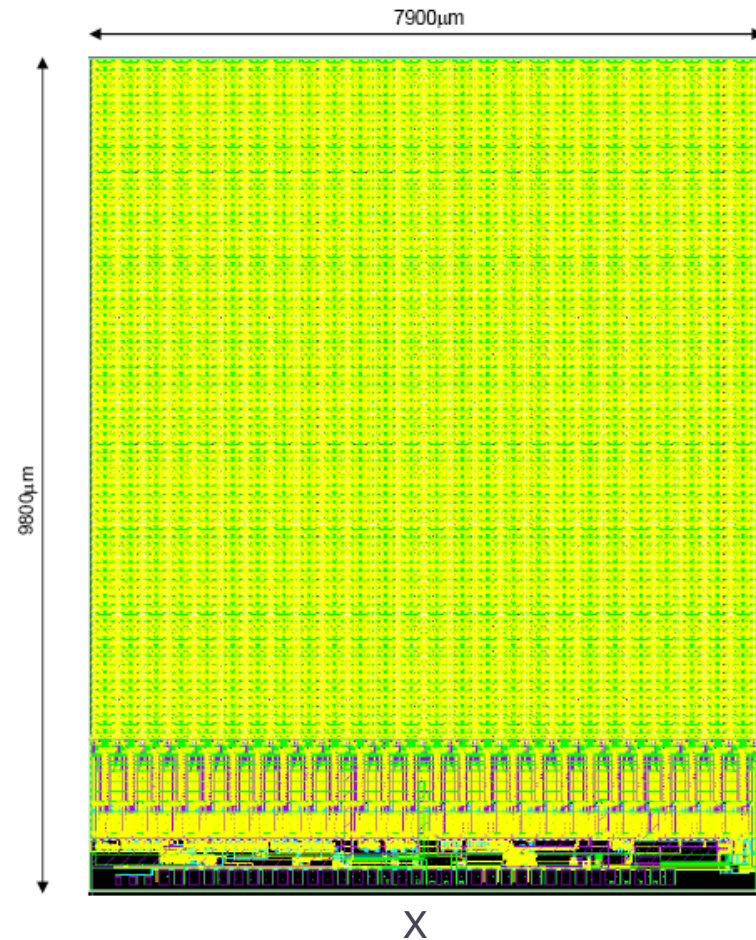

Pixel Detectors - Bump Bonding

- ▶ Electronics readout is “Bump Bonded” to the pixel sensor
- ▶ Indium bumps placed on the Sensor
- ▶ The electronics readout is aligned on top of the sensor so that the bumps line up with the connections to the amplifiers
- ▶ The layers are heated, the bump flows and creates a connection between the sensor and the readout chip

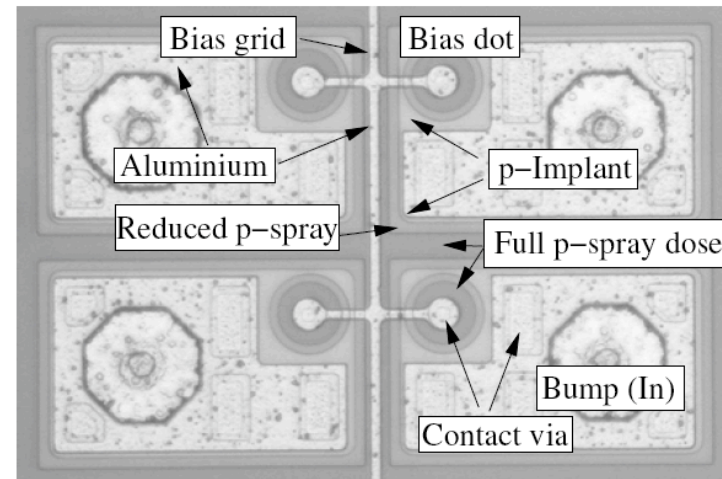
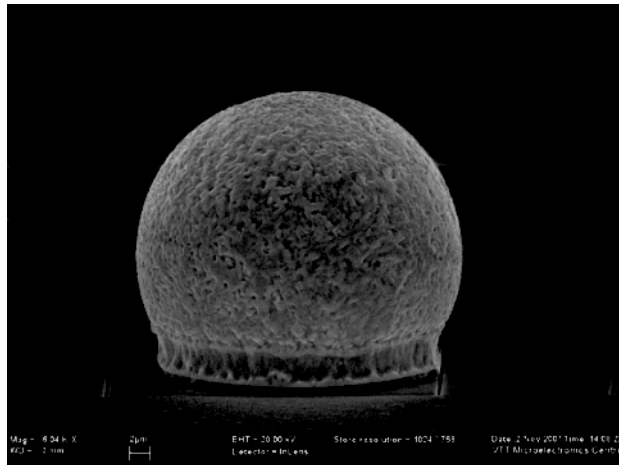
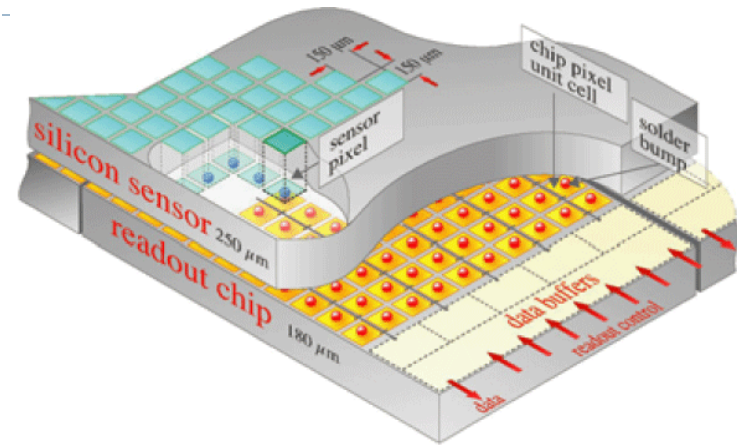

Pixel Sensors and ROC

- ▶ ROC (Read out Chip)
 - ▶ Fabricated in $0.25\mu\text{m}$ CMOS
 - ▶ Internal power regulation
 - ▶ Column Drain architecture
 - ▶ 1.3M transistors
 - ▶ $28\ \mu\text{W}/\text{pixel}$

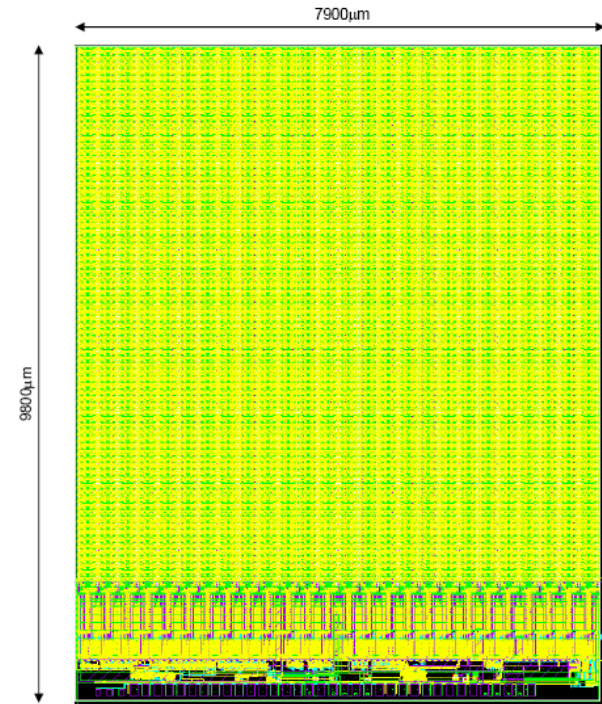

- ▶ Sensors $150\mu\text{m} \times 100\mu\text{m}$
 - ▶ (ATLAS $400\mu\text{m} \times 50\mu\text{m}$)
 - ▶ P spray on oxygenated silicon
 - ▶ Radiation hard to $10^{15}\ \text{n} / \text{cm}^2$

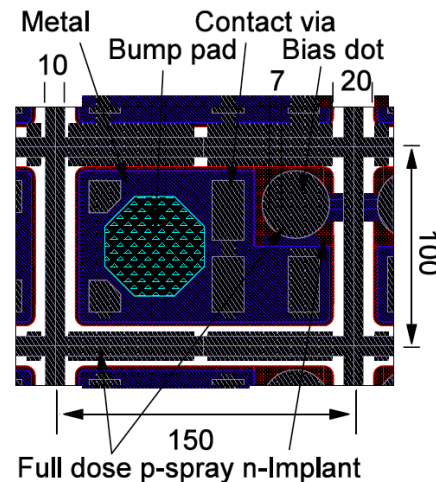

Read out Chips for Silicon

- ▶ Individual Cells signal the column level controller that they have been hit
- ▶ The controller sends a token up and down the double column
 - ▶ Only hit cells receive the token
 - ▶ When a cell receives a token it sends its address and hit date to the column controller where it is stored in a buffer
- ▶ When a Level 1 Trigger is received, the data are removed from the column buffers

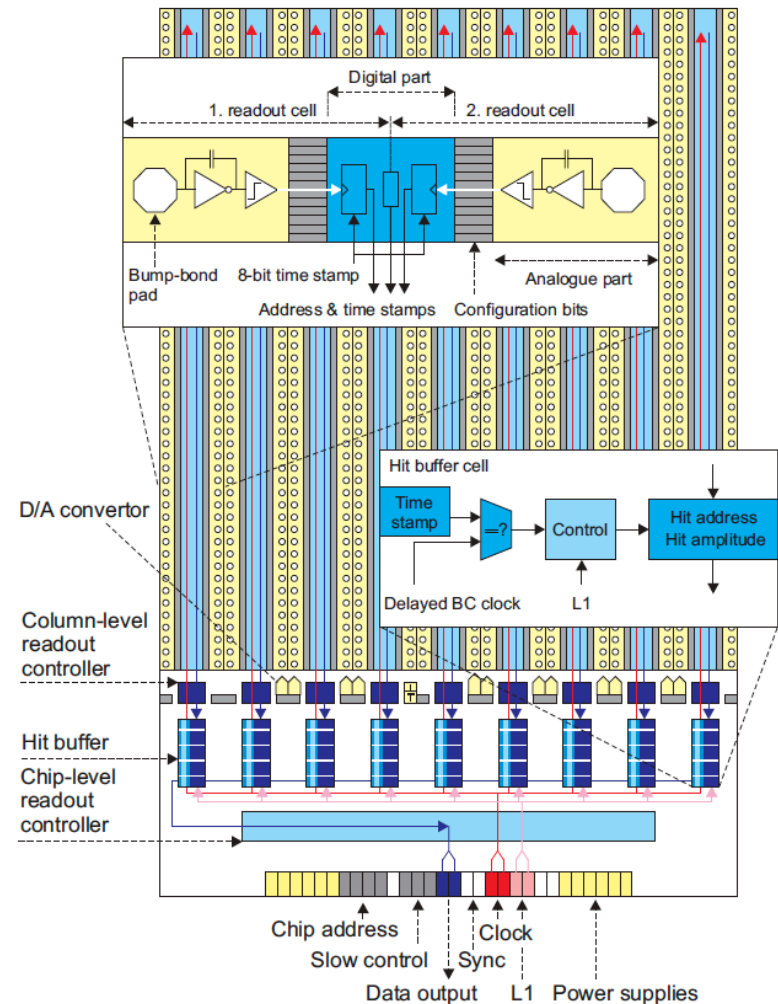

Assembly of a Pixel Module

Fabrication of modules with various glueing steps in assembly line (→ Talk: S. König)

TBM_V5 (final)

Presentation E. Bartz
Submission 9 Mai 05

Signal Cable_V3 (final)

Presentation: C. Hoermann

HDI_V3.1 (final)

Presentation C. Hoermann
Fabrication preseries (10%)
done by June 04

Bump bonding

at PSI, capacity now
3-4 modules /day
Presentation: H. Kästli

Si₃N₄ baseplate

move **caps** to HDI
simpler fabrication
150 substrates ordered
4" diameter, 250 μ thick → delivery week 29

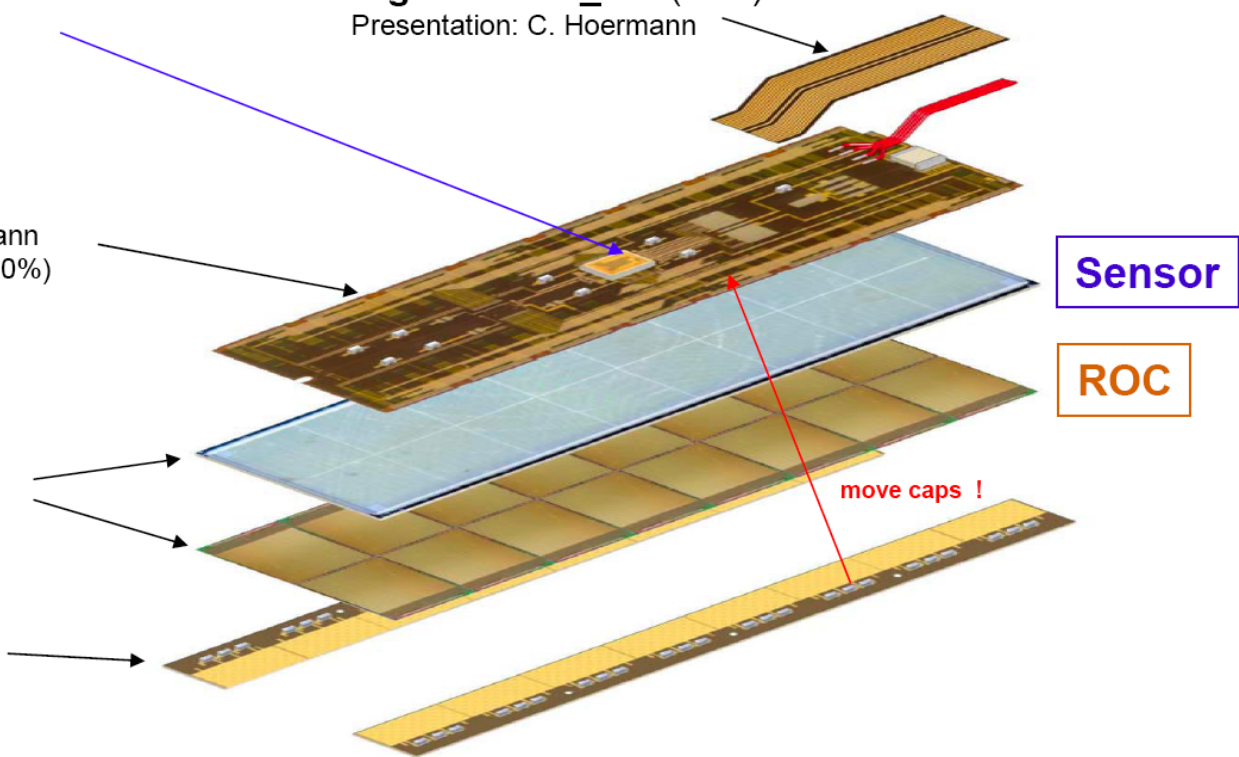

Pixel Detector

- ▶ Innermost tracking detector of CMS
 - ▶ 3 Barrel rings
 - ▶ 2 End disks
- ▶ Must withstand highest radiation doses/fluence
- ▶ Designed to be removed annually
- ▶ Largest number of channels in any CMS detector

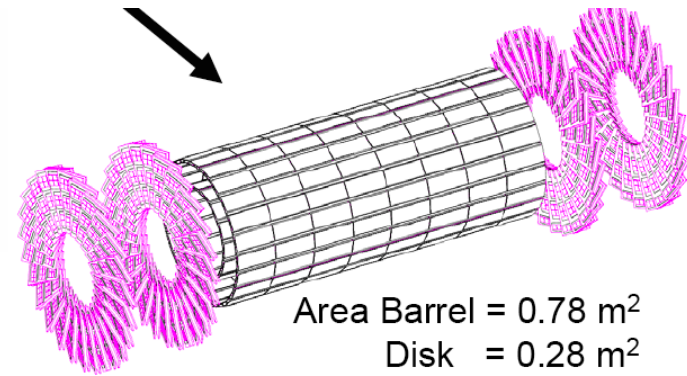

Area Barrel = 0.78 m²
Disk = 0.28 m²
Total ~ 1 m²

→ 65M Pixel

Pixel Detector System (Barrel & Forward)

- Beam pipe bake out → insertion/removal of pixel detector
- Rail system for FPIX & BPIX & supply tubes

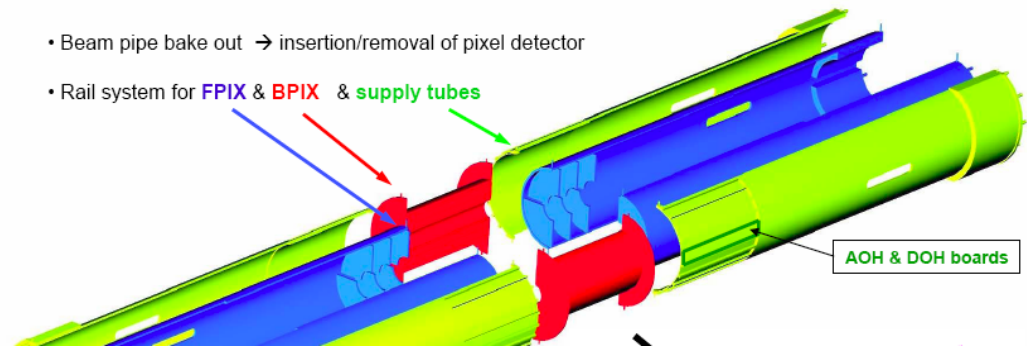

ATLAS and CMS Pixel Detectors

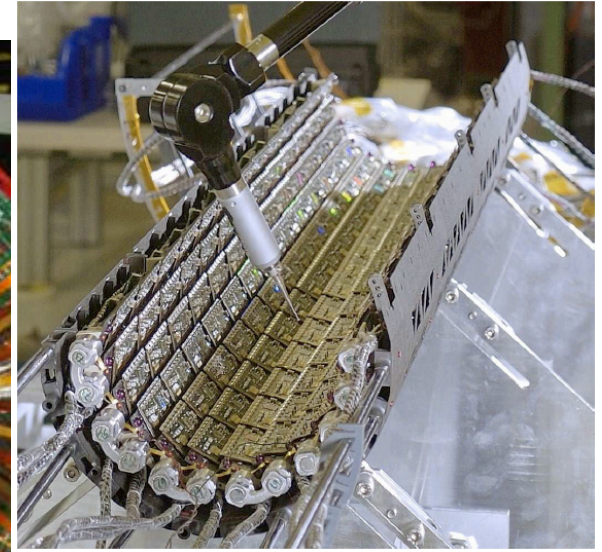
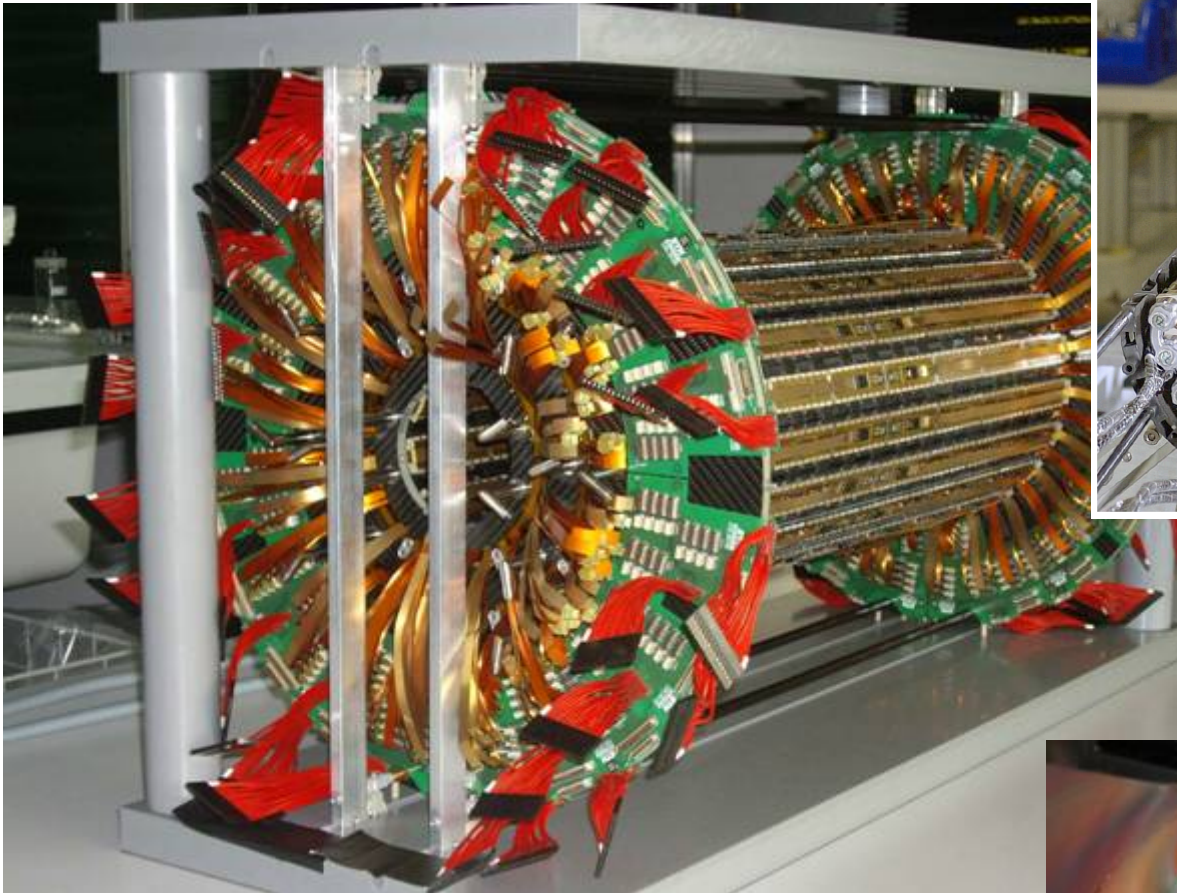

Radiation environment for trackers

Except for the very innermost layers many current technologies should survive HL-LHC

L=2500fb⁻¹, Fluence .vs. Radius

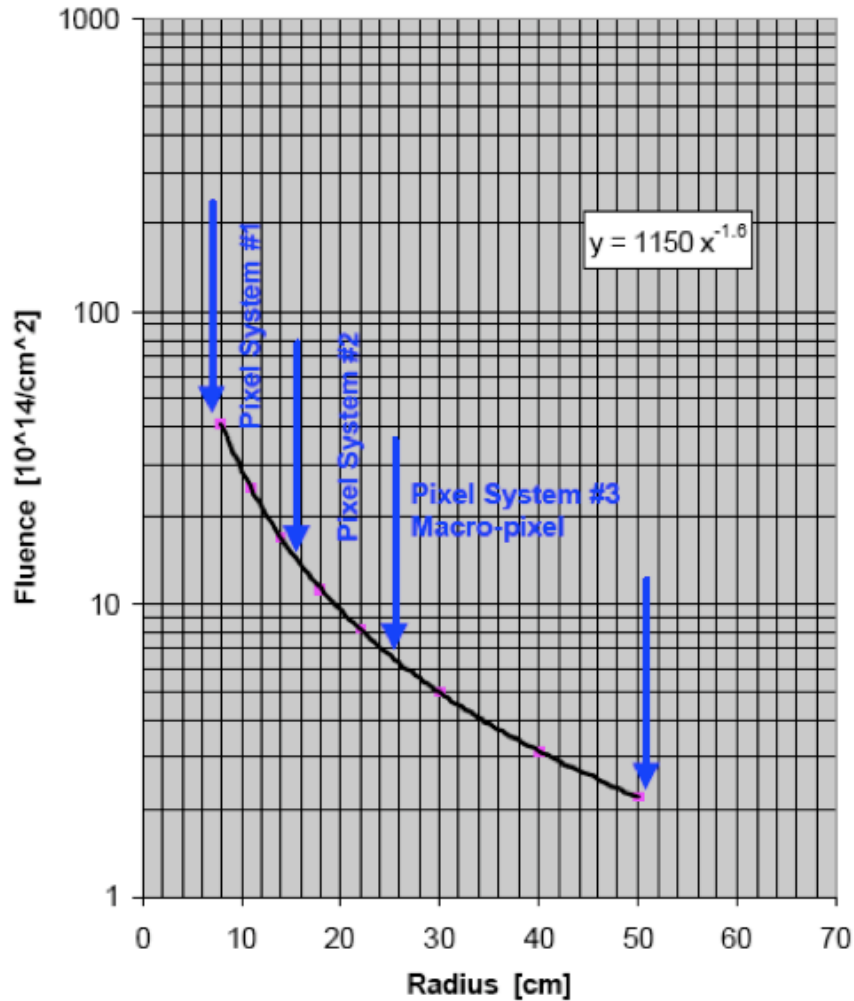

Radiation Dose in Inner Detectors

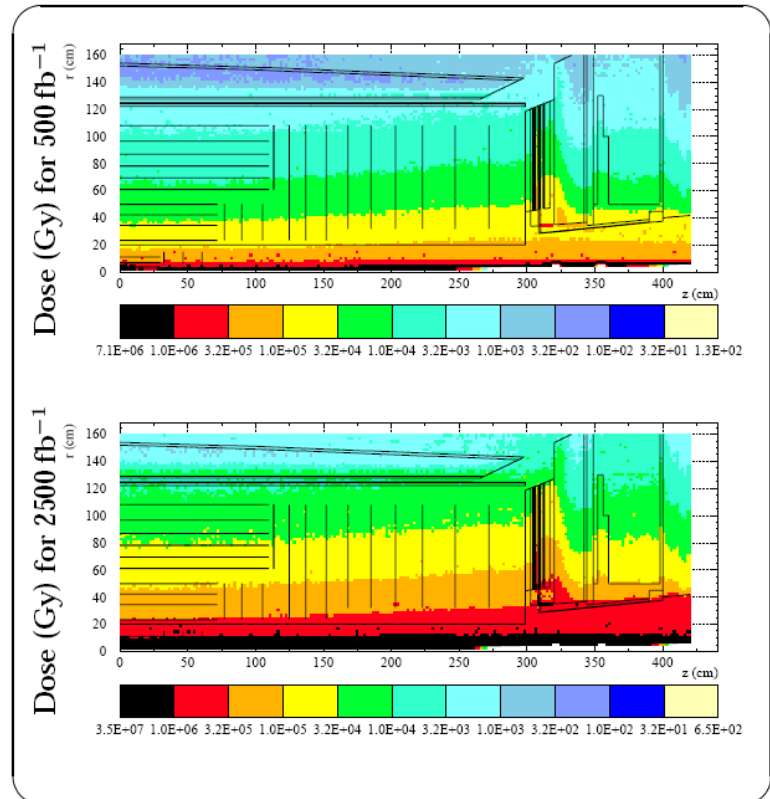

M. Huhtinen

SLHC Electronics Workshop 26 February 2004

3

Silicon strip detectors

- ▶ Can't build an infinitely large pixel detector
 - ▶ Too many channels
 - ▶ Too expensive!
- ▶ Strip detectors can cover a larger area with less readout channels
 - ▶ Strips are placed separated by $\sim 100\mu\text{m}$
 - ▶ Metal of strip $\sim 15\mu\text{m}$
 - ▶ They are typically around 10cm long
 - ▶ Only a 2D resolution possible
 - ▶ Some 3D possible with "Stereo" layers

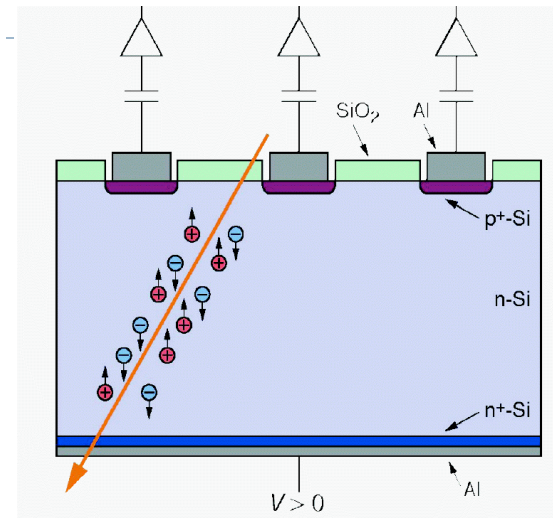

Connecting to the readout

- ▶ Connections to Silicon strips is done with ultrasonic wire-bonding
- ▶ This is a standard industry practice
 - ▶ Repairs can be made for badly made bonds
- ▶ Much easier to produce a detector that covers a large surface area

Sensor Design Baseline

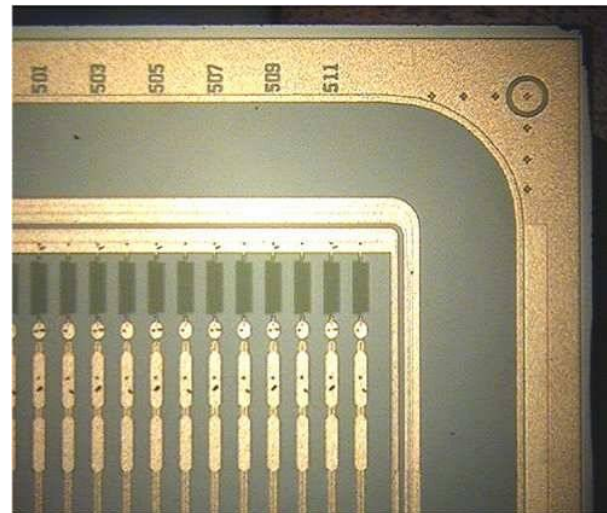
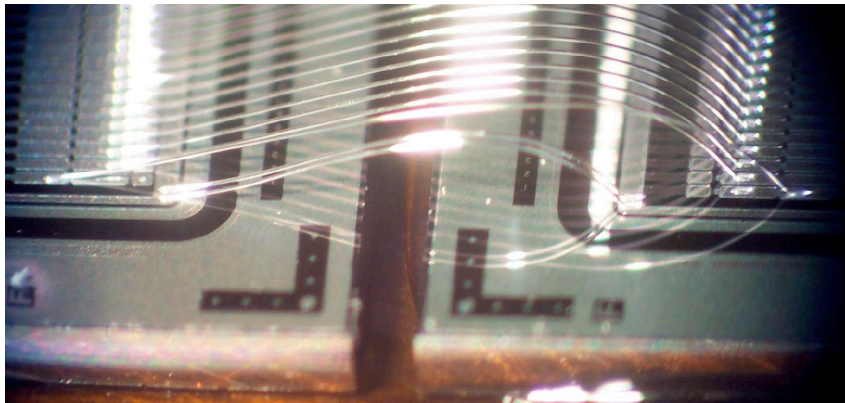
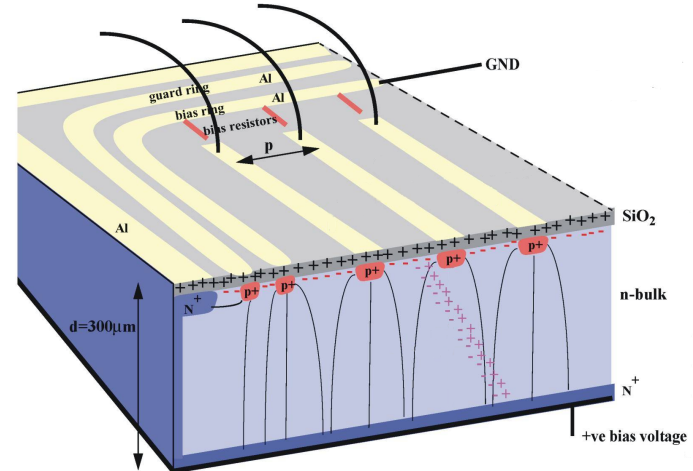

Readout electronics

- ▶ Readout example APV25
 - ▶ One chip reads 128 strips
- ▶ Fast signal shaping
 - ▶ Sampled signal stored in a pipeline
- ▶ Pipeline takes up much of the chip
 - ▶ Determines CMS Maximum level 1 latency
 - ▶ When a Level 1 Trigger arrives the data from all 128 strips are shipped out

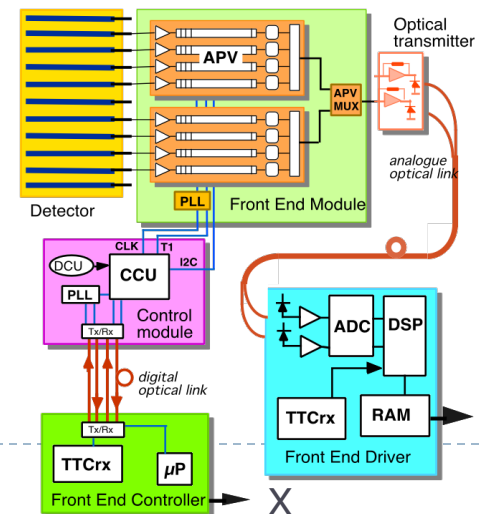
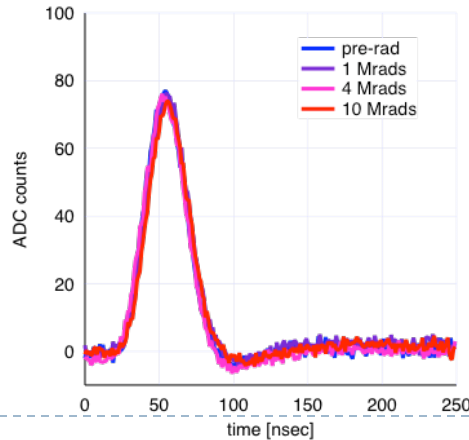
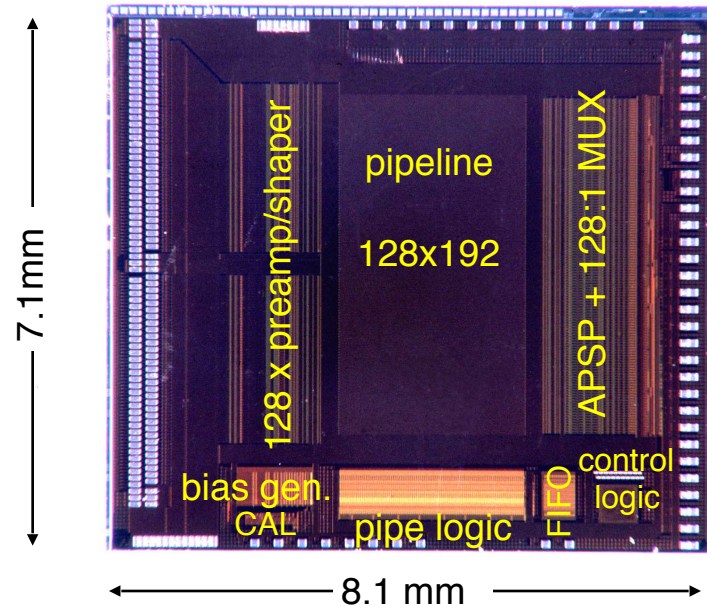

Building Silicon Modules

- ▶ Silicon Wafers are produced with strips on them
- ▶ Hybrids with readout chips and connections for power, readout are wire bonded to the strips
- ▶ A huge number and variety of these modules was required to build the LHC Silicon Strip detectors
 - ▶ CMS 16,000 Modules
 - ▶ 10,000,000 Strips

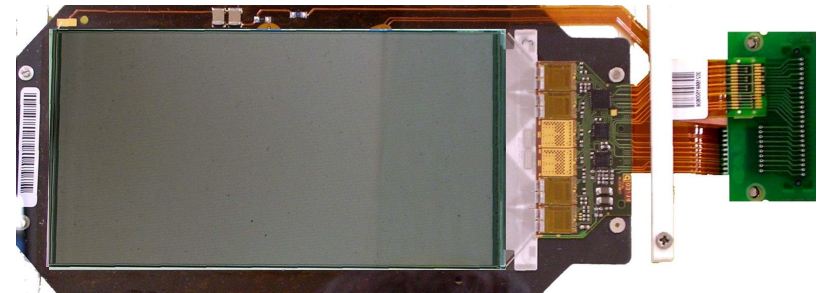
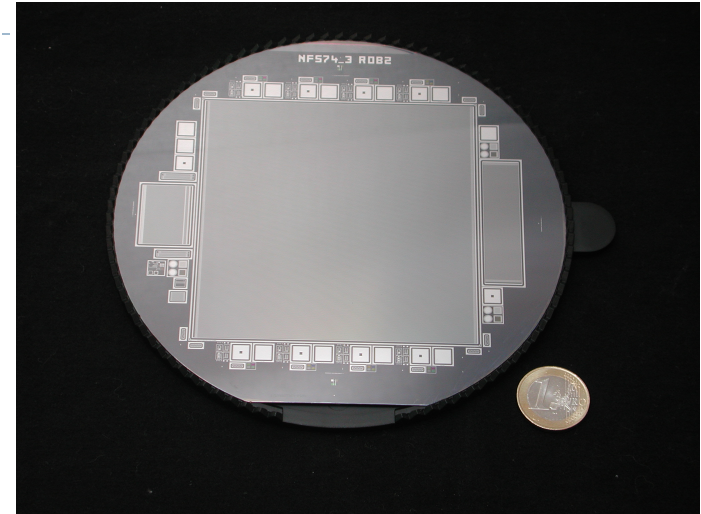

Building full size trackers

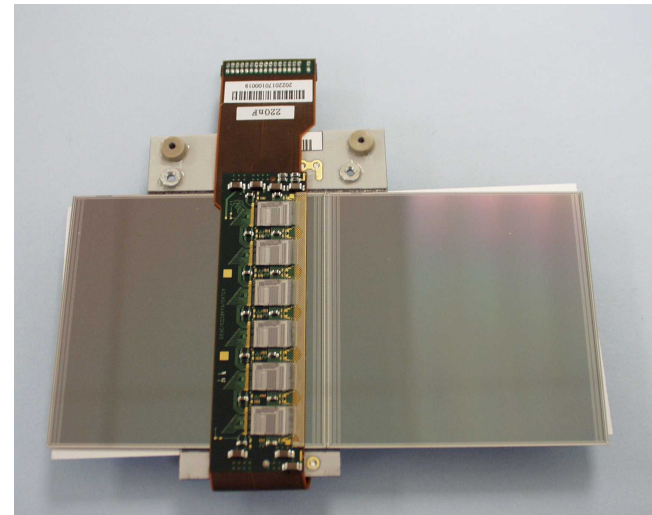
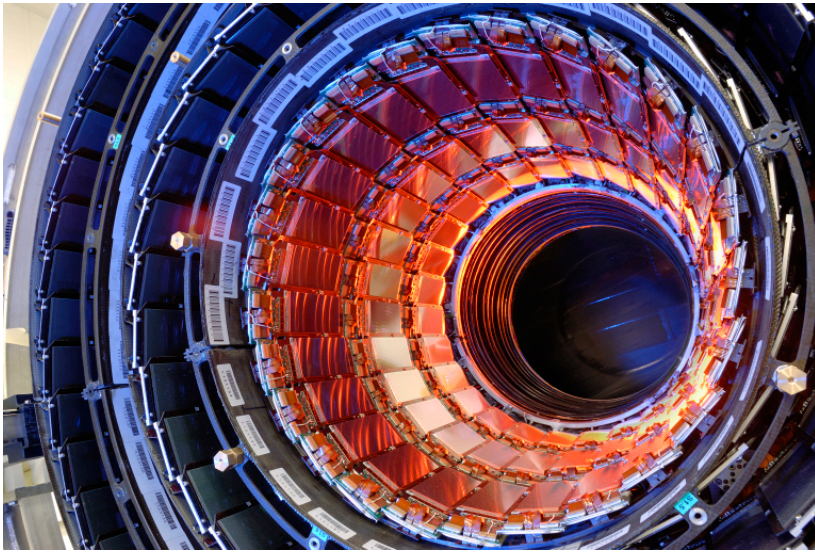
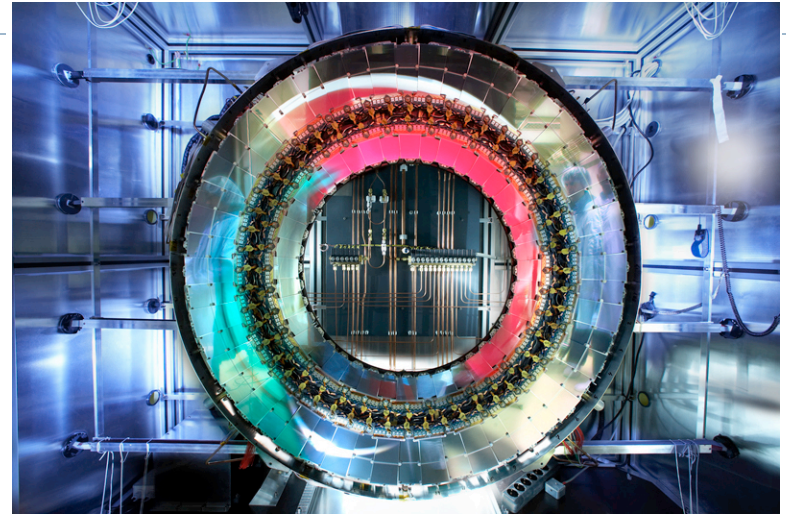
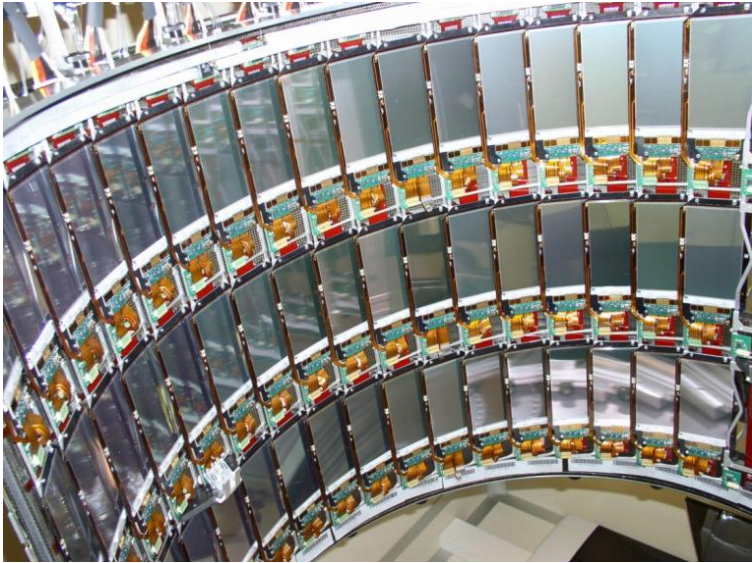

Tracker Readout

- F. Vasey et al

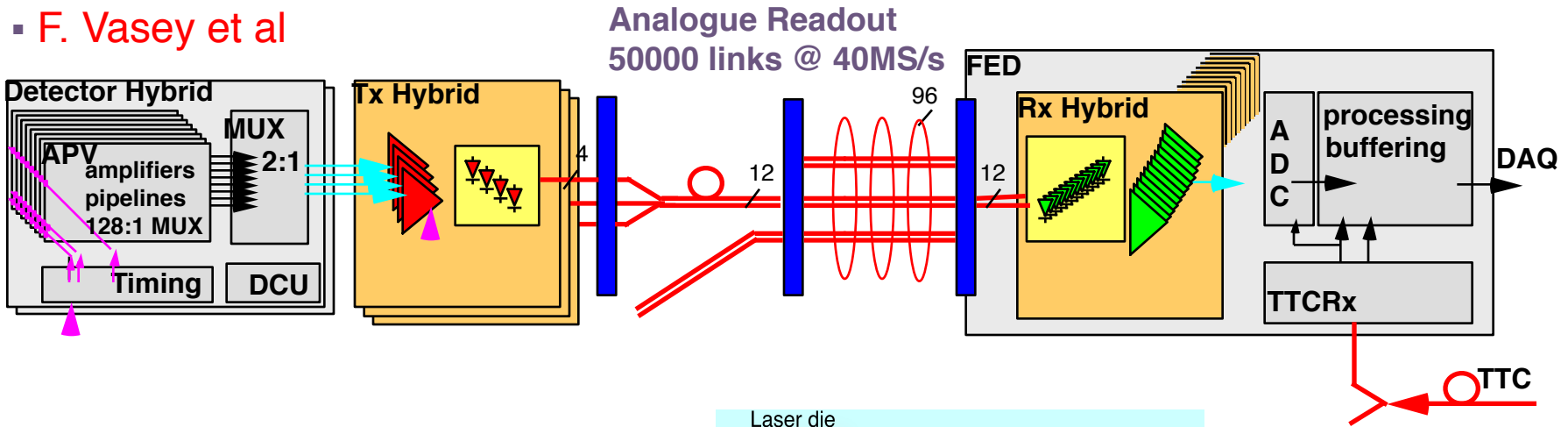

- ▶ Tracker readout is analogue signal from APV sent over optical fibre
- ▶ Edge emitting $1.3\mu\text{m}$ InGaAsP MQW laser diodes
 - ▶ single mode fibre $\sim 50\text{mW}/256$ detector channels
 - ▶ 50,000 optical links for tracker
- ▶ Analogue signal is digitized in off detector electronics (FED)
 - ▶ Around 500 FEDs required

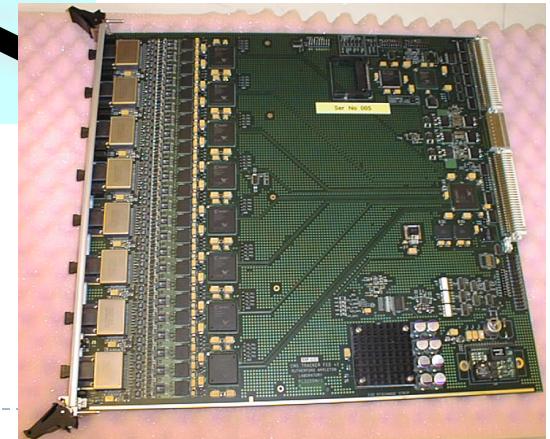
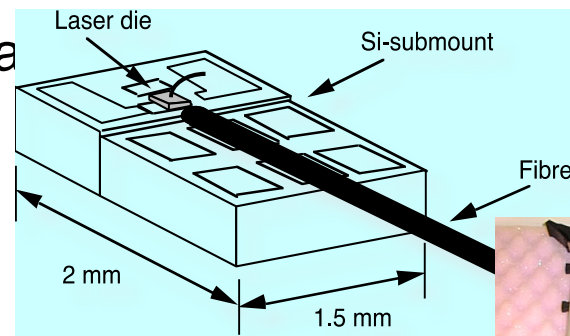

Full size tracker – a lot of cables!

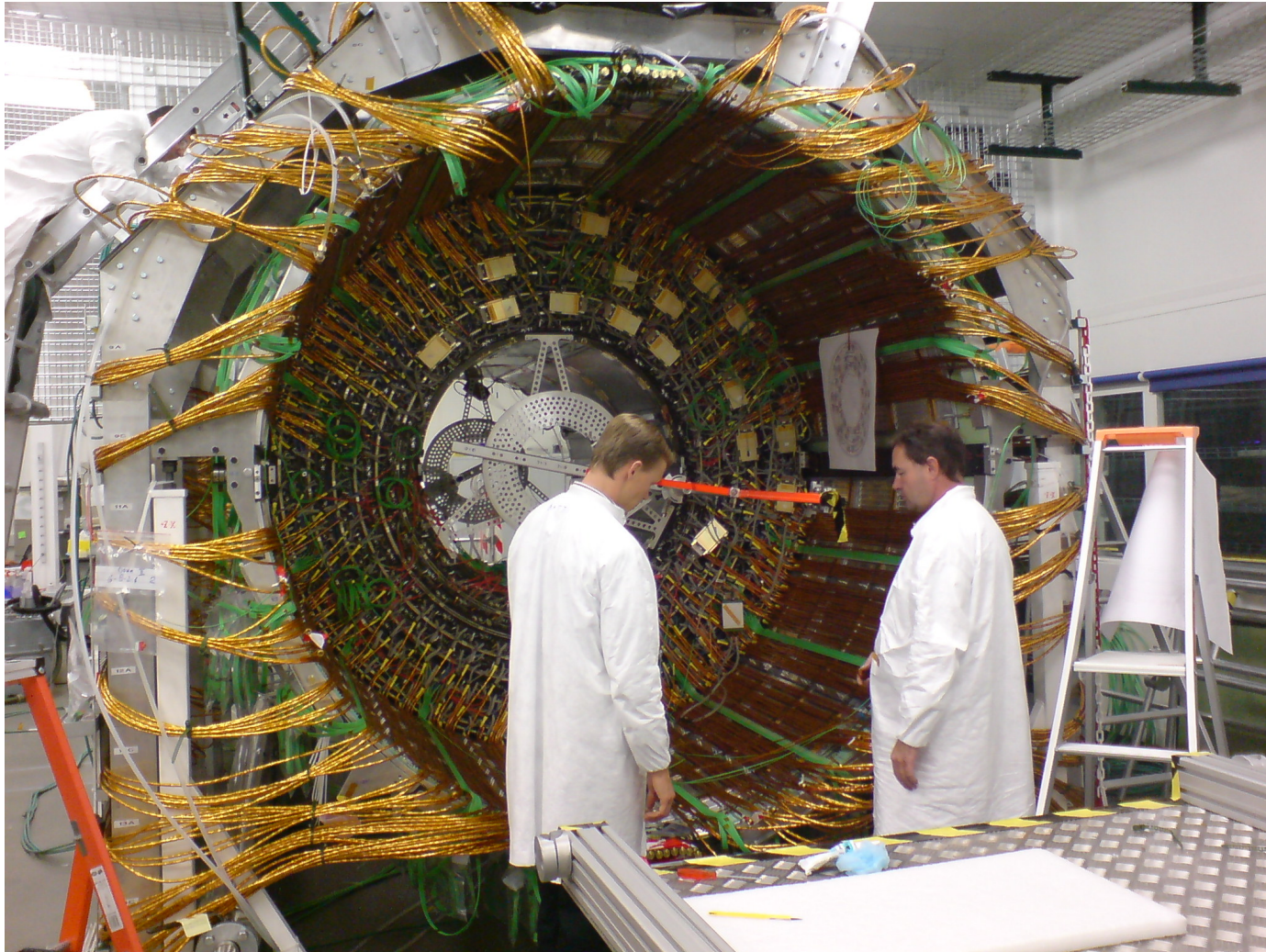

Tracker Material

- ▶ Although the tracker is made of silicon, there is a large amount of material required for the electronics
 - ▶ Sensors
 - ▶ Support
 - ▶ Cooling
 - ▶ Power Cables
- ▶ Minimizing this was a big task, and taking this a step further would be a big goal of any upgraded tracker
- ▶ Consider how many photons produced convert before they escape the volume of the tracking devices
 - ▶ Electrons also will have a high probability of losing energy via Bremsstrahlung

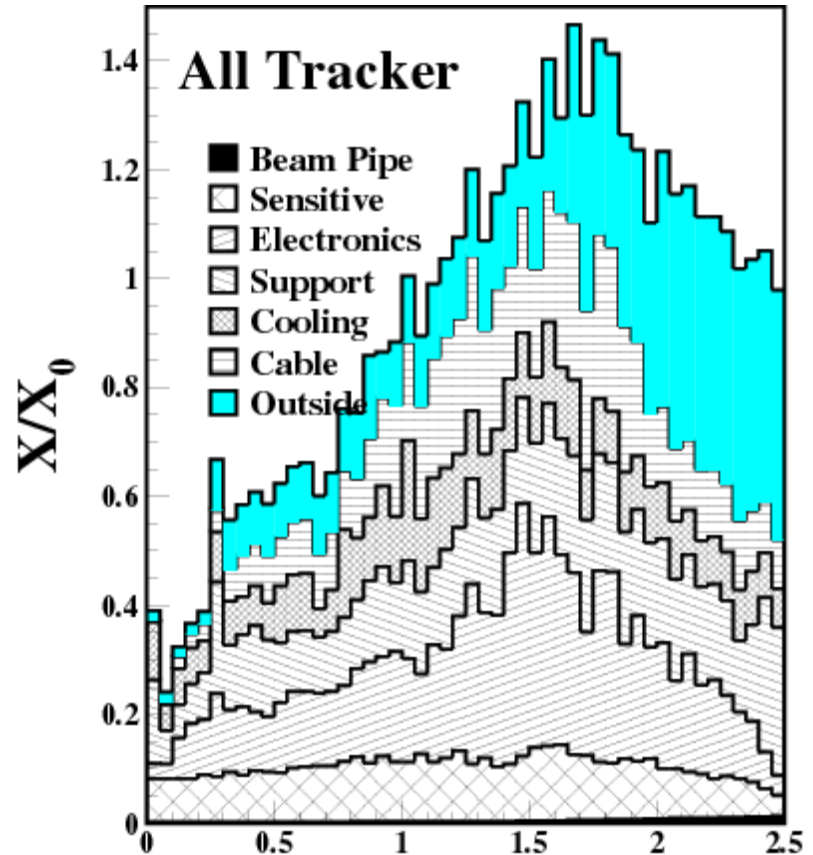

Intrinsic performance of tracking

| Item | Intrinsic accuracy (μm) | Alignment tolerances (μm) | | |
|----------------|-----------------------------------------|-------------------------------------------|-----------|----------------------|
| | | Radial (R) | Axial (z) | Azimuth (R- ϕ) |
| Pixel | | | | |
| Layer-0 | 10 (R- ϕ) 115 (z) | 10 | 20 | 7 |
| Layer-1 and -2 | 10 (R- ϕ) 115 (z) | 20 | 20 | 7 |
| Disks | 10 (R- ϕ) 115 (R) | 20 | 100 | 7 |
| SCT | | | | |
| Barrel | 17 (R- ϕ) 580 (z) ¹ | 100 | 50 | 12 |
| Disks | 17 (R- ϕ) 580 (R) ¹ | 50 | 200 | 12 |

- ▶ Pixels give the most detailed information
 - ▶ Including the best information in Z (Along the beam line)
- ▶ The 2D strip detectors give some Z information when they are read out in stereo pairs
 - ▶ Two parallel layers back to back with a small angle between them
 - ▶ correlation between the hit strips can determine where the particle went through the detector in Z
- ▶ Intrinsic position resolution is very good on a single Silicon module
 - ▶ Silicon is very precisely manufactured
- ▶ However all the individual modules need to be aligned with respect to each other in order to have a global understanding of where the particles have travelled

LHCb

Vertex Detector - VELO

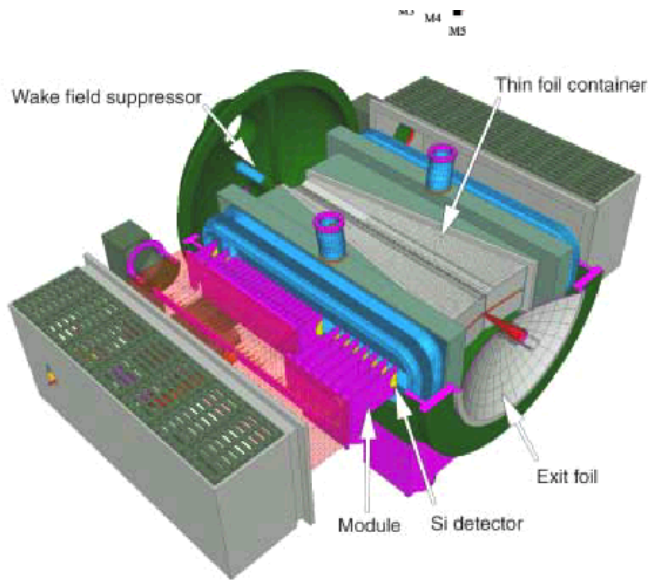

Number of silicon sensors: 100
 Area of silicon: 0.32m²
 Number of channels: 204,800

Φ sensor
 2048 strips total

R sensor
 2048 strips total

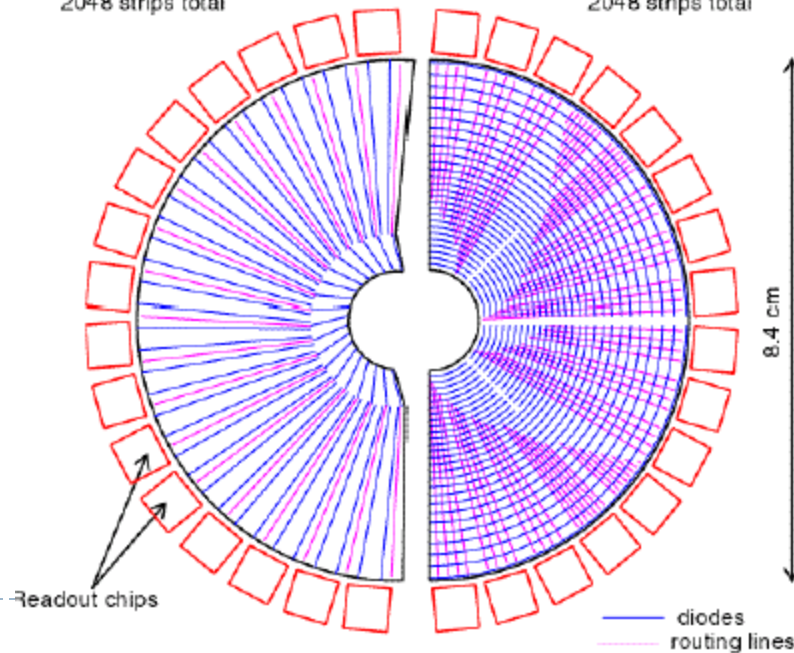
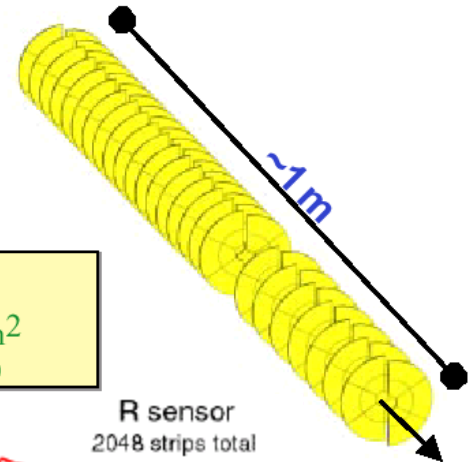

Velo

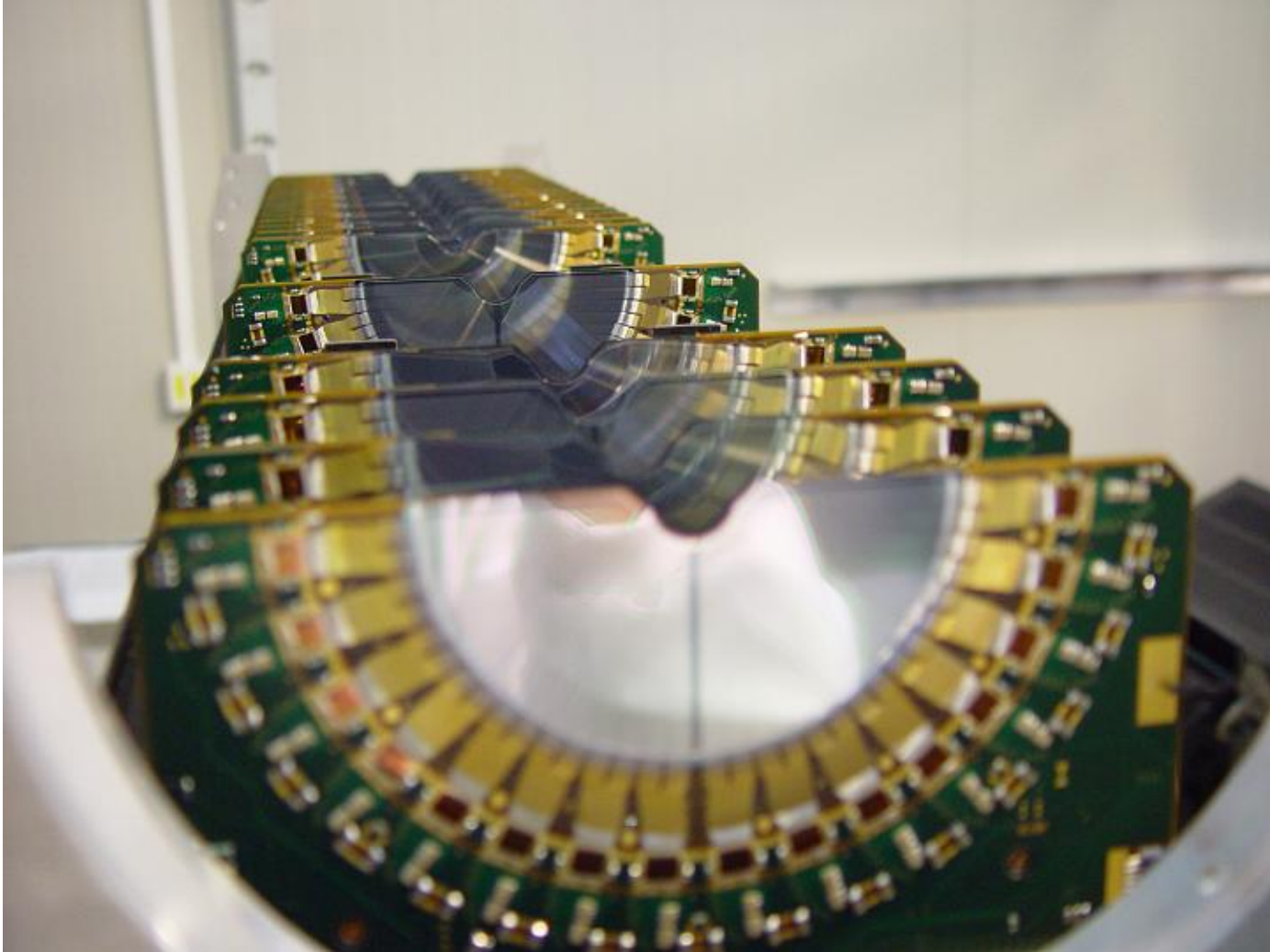

Wire chambers and Avalanches

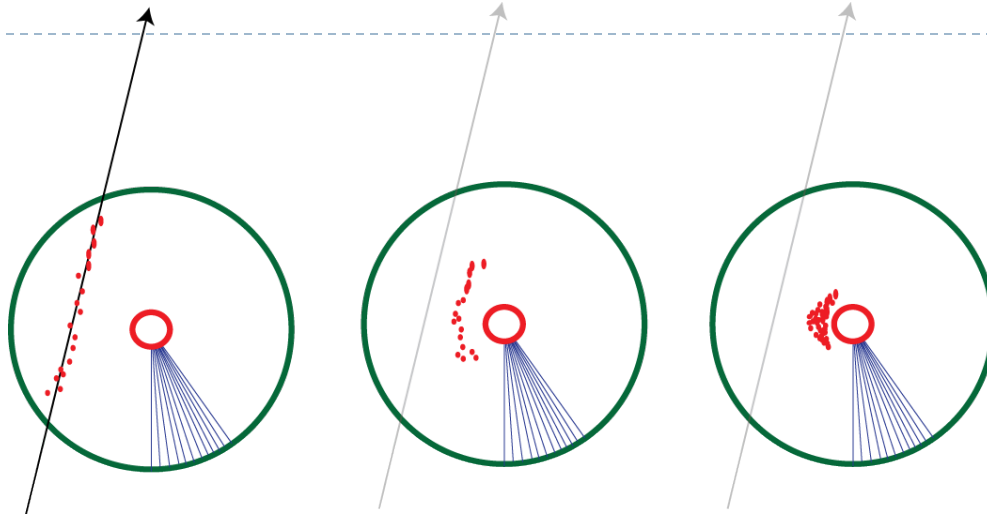

Chamber consists of an inner wire held at a positive Voltage (anode) of radius a , and outer cylinder (cathode) of radius b which is filled with gas

Charged particle passes through gas ionizing gas molecules

Electrons drift towards the central wire (anode) along the electric field lines

The electric field value gets very high near the anode – drifting electrons create more ionization. This causes an *Amplification* of the charge arriving on the anode wire

Electric Field

$$E(r) = \frac{\lambda}{2\pi\epsilon_0 r} = \frac{V_0}{\ln \frac{b}{a}} \frac{1}{r}, \quad V(r) = \frac{V_0}{\ln \frac{b}{a}} \ln \frac{r}{a},$$

- ▶ For a wire with radius $30\mu\text{m}$ in a cylinder of 4mm fields reach 400Kv/cm near the wire surface

Electric Field (V/cm)

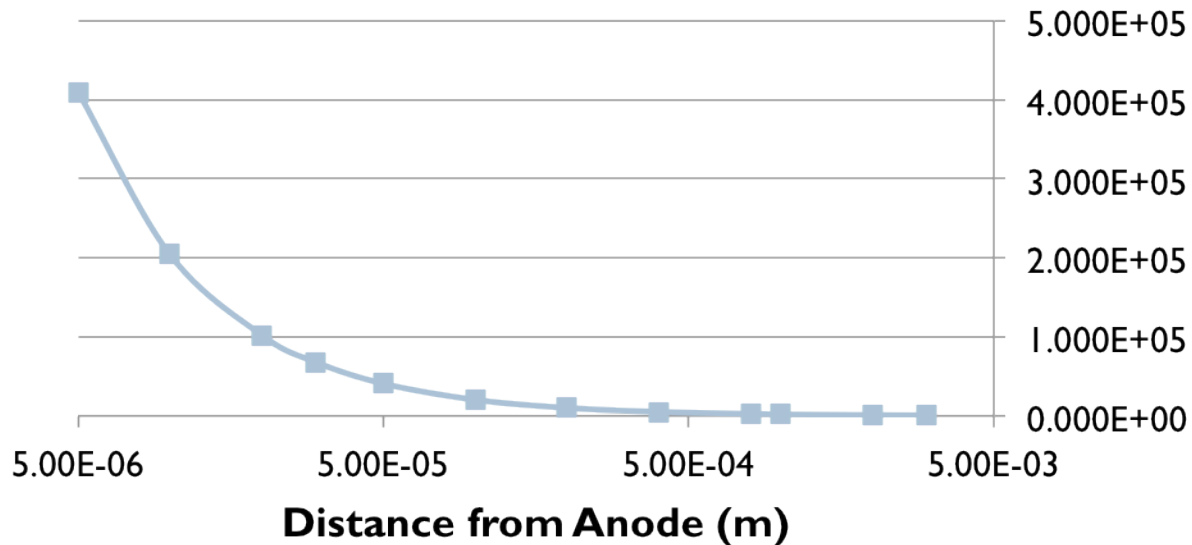

Wire of radius a
outer cylinder of
radius b

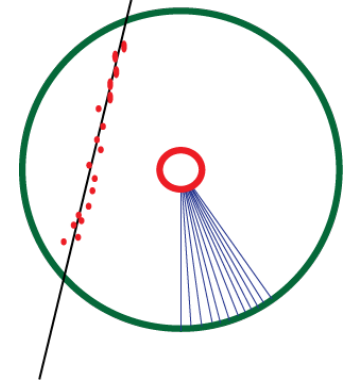

Avalanche Characteristics

- ▶ As the electrons approach the anode, the field grows very rapidly
- ▶ Electrons create more electrons by collision with a mean free path which gets shorter as the electrons approach the anode and the Electric field grows
- ▶ Townsend coefficient estimates the mean free path as a function of field (or radius)
- ▶ Can calculate the Multiplication factor
 - ▶ The number of electrons reaching the anode compared to how many were produced in the initial ionization

Avalanche Multiplication Factor

$1/\alpha \equiv$ mean free path

$n_0 =$ number of electrons

$dn = n\alpha dr$

$n = n_0 e^{\alpha r}$

$M = n/n_0$

$M = e^{\int_a^r \alpha(r) dr}$

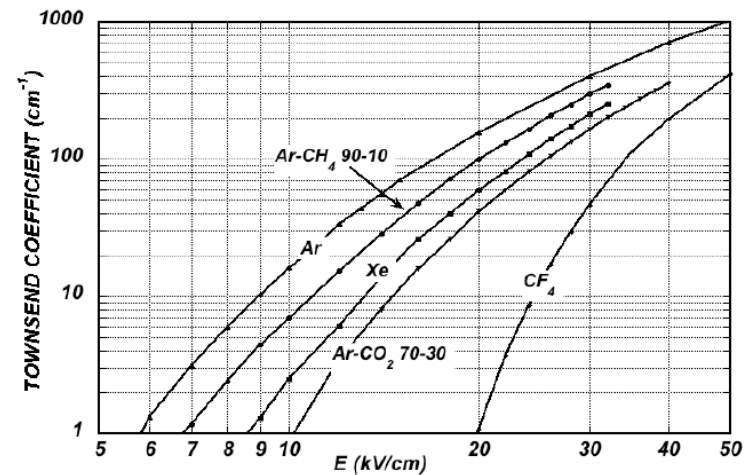

Avalanche Modes

- ▶ Wire chambers can operate at many different gas gains
 - ▶ Proportional mode $M = 10^3$ - 10^4 —
 - ▶ the number of ions measured is proportional to the ionization
- ▶ Up to Geiger mode
 - ▶ $M=10^9$
 - ▶ Avalanches propagated by products of initial avalanche
 - ▶ No relation of the signal to the primary ionization

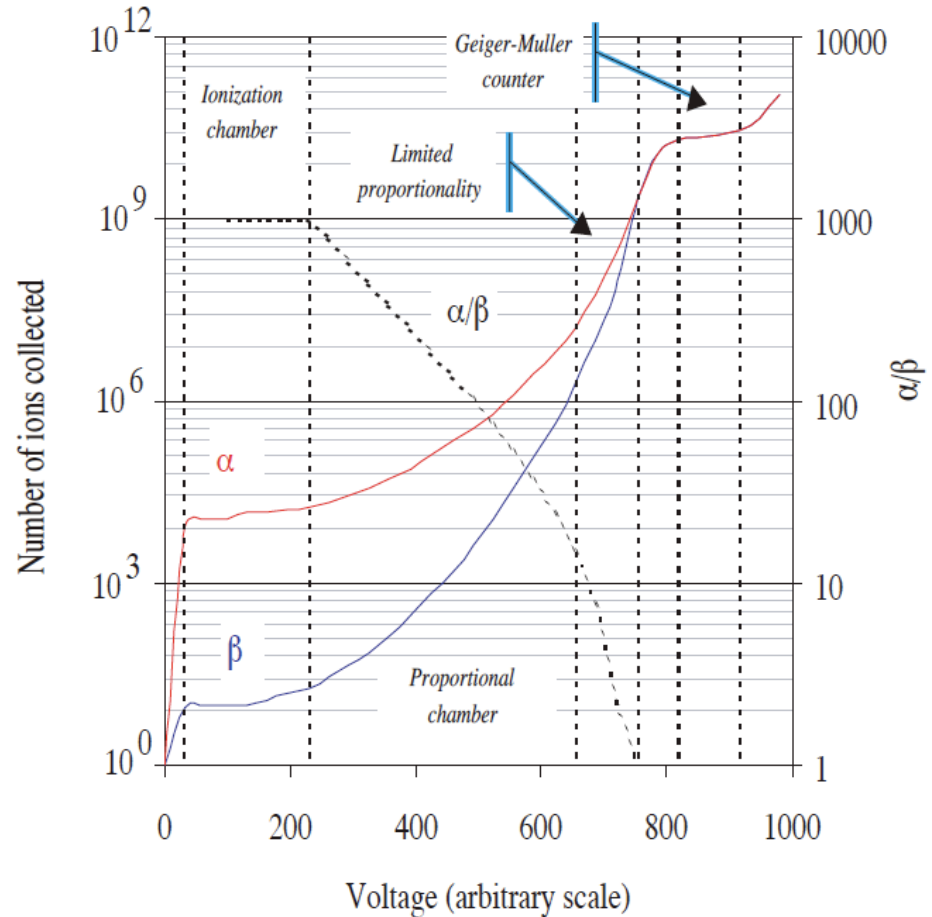
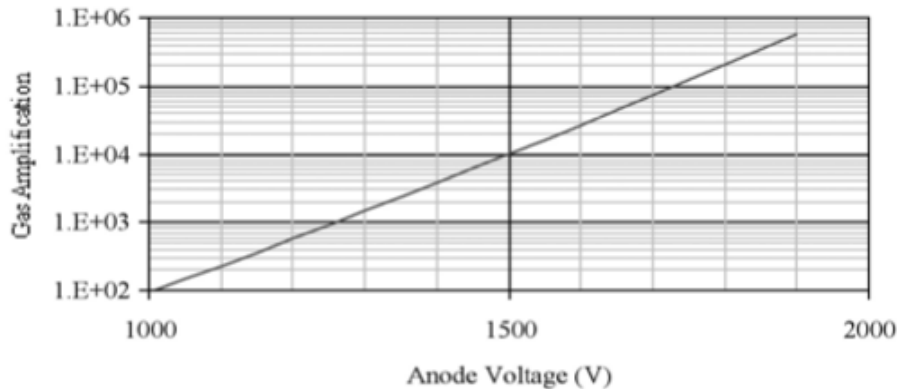

Drift Velocity

- ▶ Electrons undergo many collisions and drift at a relatively slow velocity towards the anode
 - ▶ *Drift Velocity (top curve)*
- ▶ The electron *characteristic energy* (bottom curve) stays well below ionization energies up to a certain threshold in field value
 - ▶ Depends on gas composition
- ▶ Look to operate wire chambers with gasses where the drift velocity is relatively stable with varying Electric field

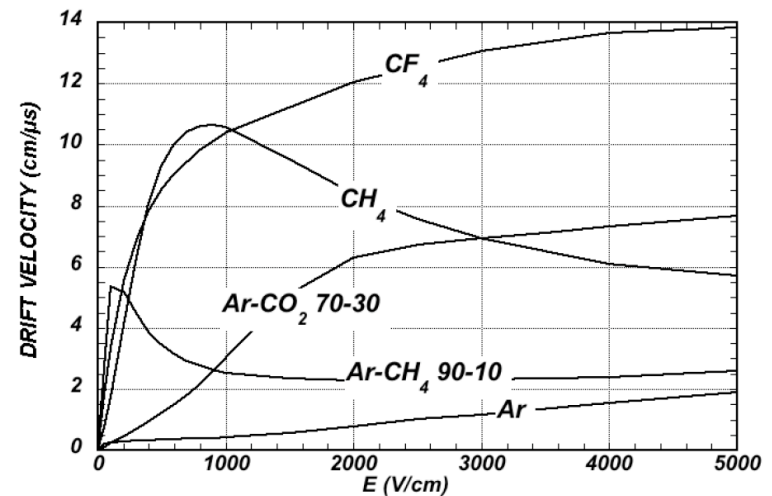
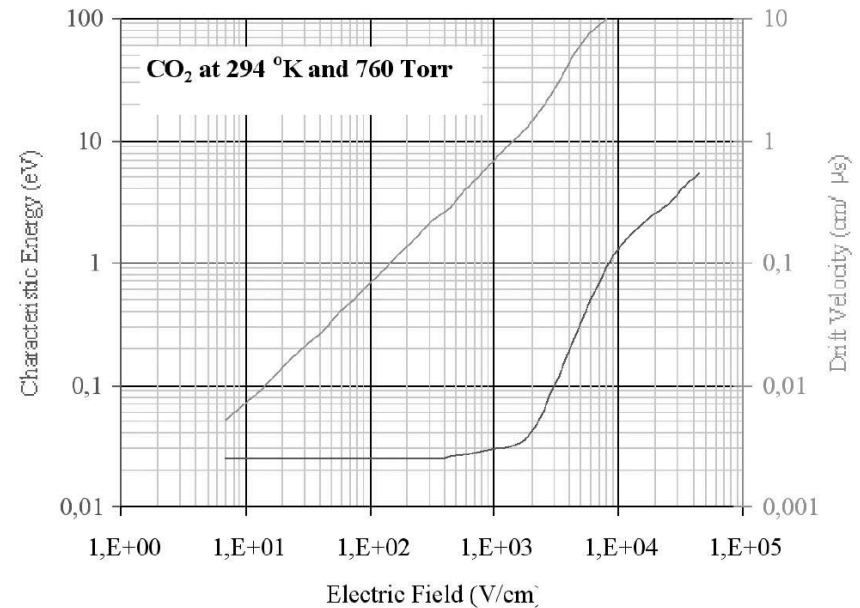

ATLAS TRT – Wires for inner detector

- ▶ The outer part of the ATLAS Inner Detector consists of “Straw” tubes.
- ▶ These are 4 mm diameter tubes with a 30 μm wire inside
 - ▶ Aluminium on the inside of the straw-tube covered with highly insulating Kapton
 - ▶ Stiffened with carbon fibre
- ▶ Gas gain 2×10^4
 - ▶ limited streamer mode
- ▶ All detector components designed to operate in the high radiation environment that the Inner Detector requires

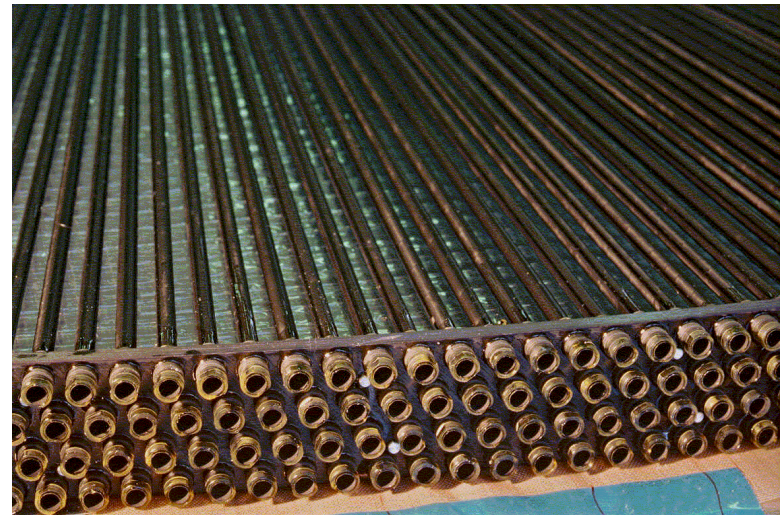
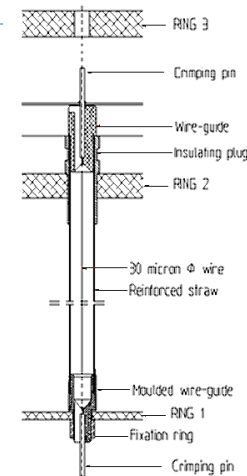

TRT performance

- ▶ Particles drift to the anode
- ▶ Drift time is quite rapid
 - ▶ Maximum drift distance is only 2mm
- ▶ Can operate at high rates
 - ▶ Up to 20 MHz
- ▶ Measuring the drift time allows us to determine the position of passage of the charged track through the straw
 - ▶ Uncertainty in the drift time gives an uncertainty in the position measured

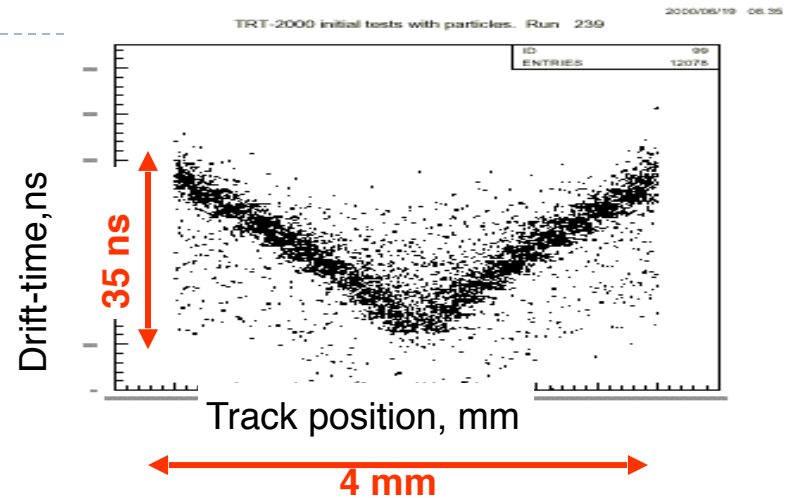

- ▶ This detector also contains a radiator so that Transition Radiation can be detected
 - ▶ (We will discuss this when we talk about Particle Identification)

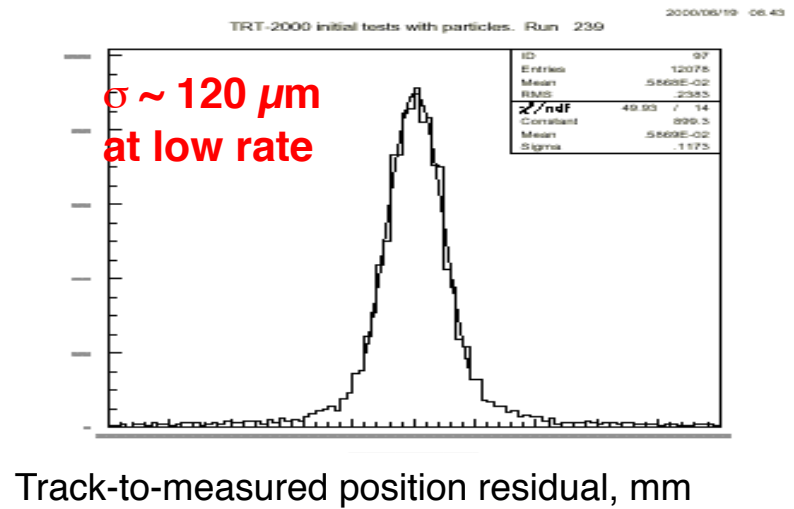

TRT Detector

TRT global parameters

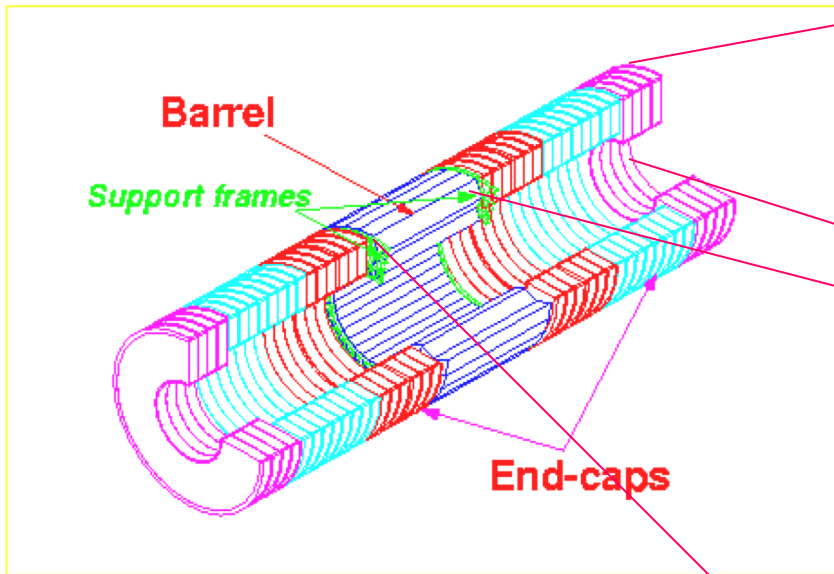

Radiator

Straws

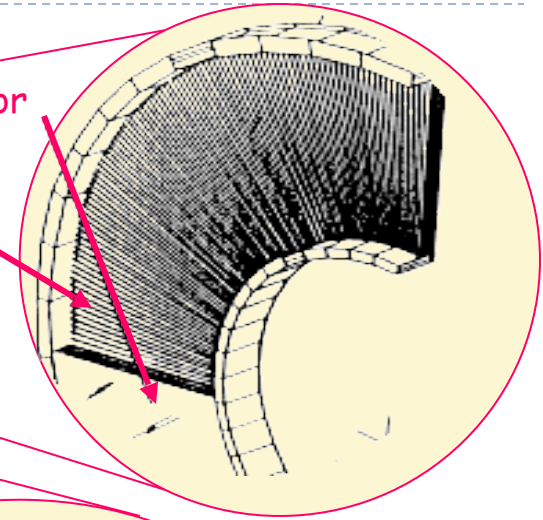

Radiator

Straws

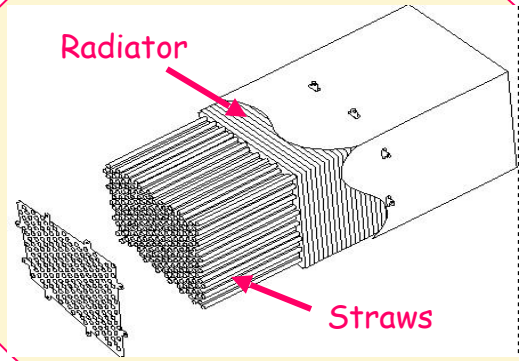

| | | | |
|----------------|-----------|------------------------|-----------|
| Length: Total | 6802 cm | N straws: Total | 372032 |
| Barrel | 148 cm | Barrel | 52544 |
| End-cap | 257 cm | End-cap | 319488 |
| Outer diameter | 206 cm | N electronics channels | 424576 |
| Inner diameter | 96-128 cm | Weight | ~ 1500 kg |

Time Projection Chamber (TPC):

Gas volume with parallel E and B Field.
B for momentum measurement. Positive effect: Diffusion is strongly reduced by E/B (up to a factor 5).

Drift Fields 100-400V/cm. Drift times 10-100 μ s.
Distance up to 2.5m !

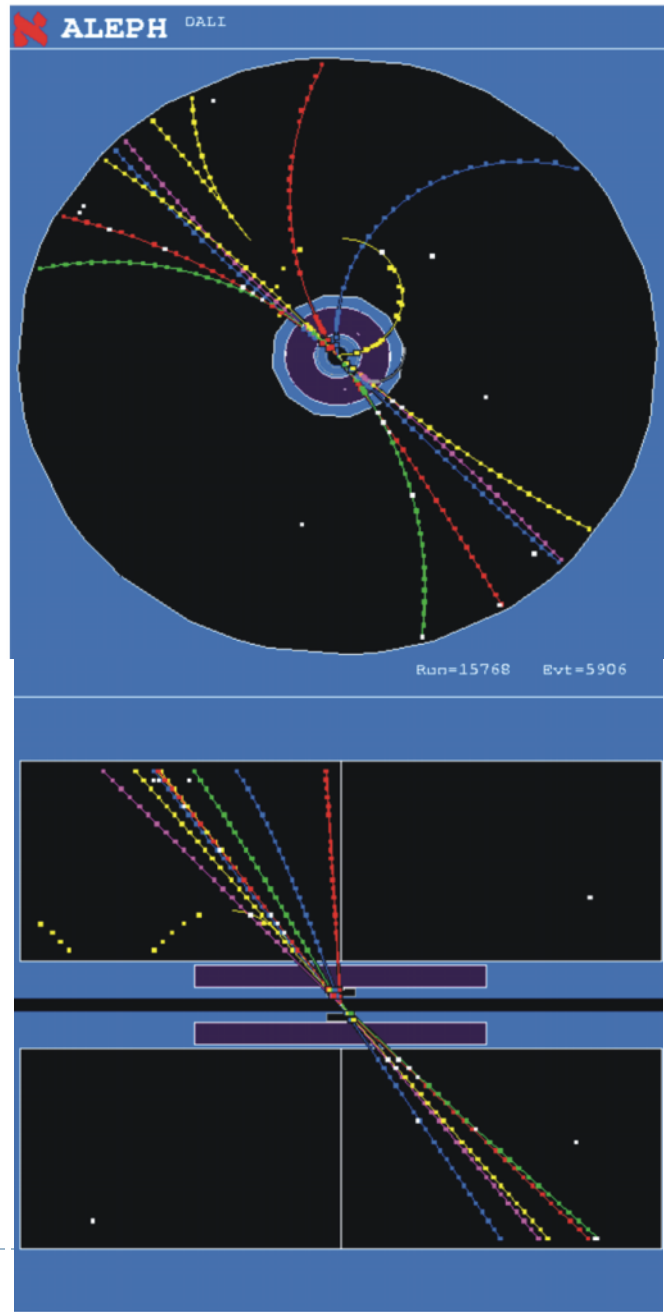
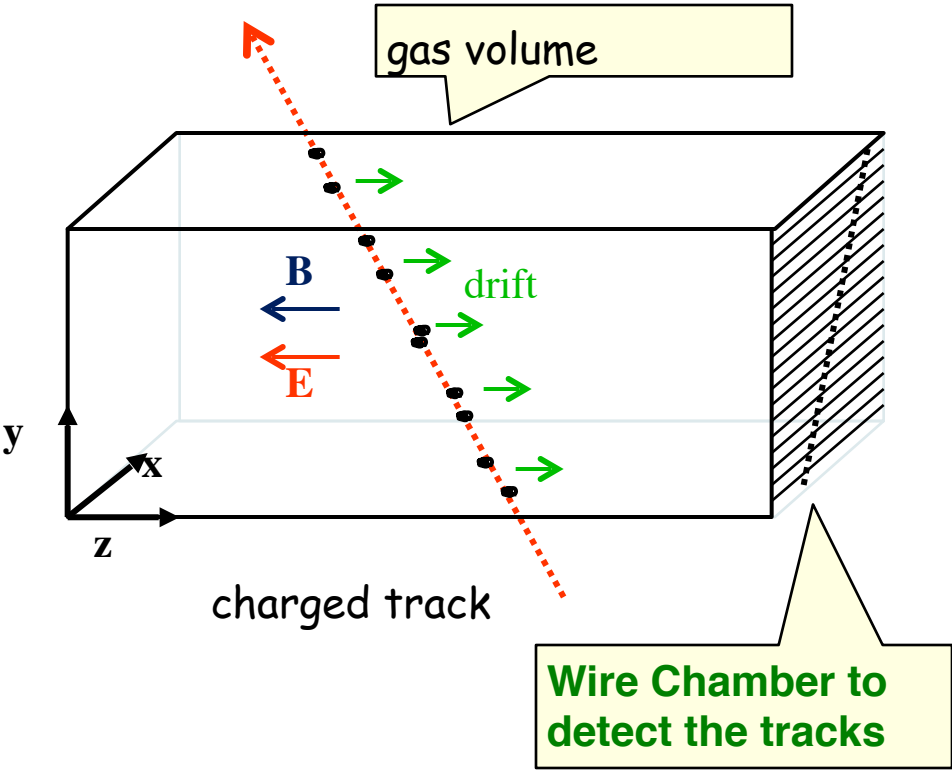

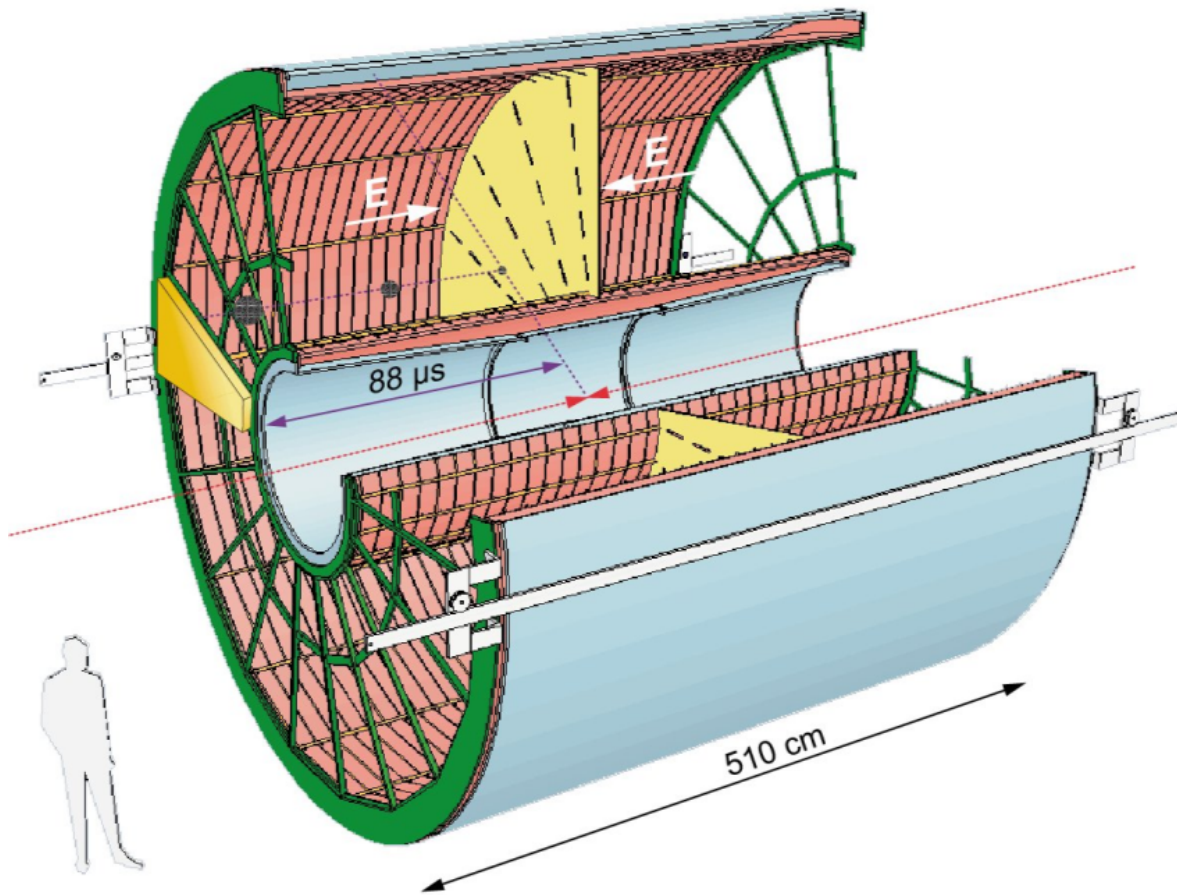

ALICE TPC

TPCs offer the advantage of very low material (only the gas inside) as well as three dimensional resolution of hits

The TPC is impractical for the GPD detectors (ATLAS and CMS) as they don't handle the high rate of interactions of the high luminosity detectors

Heavy Ion collisions have a much lower rate in ALICE and so the TPC can be used

TPC

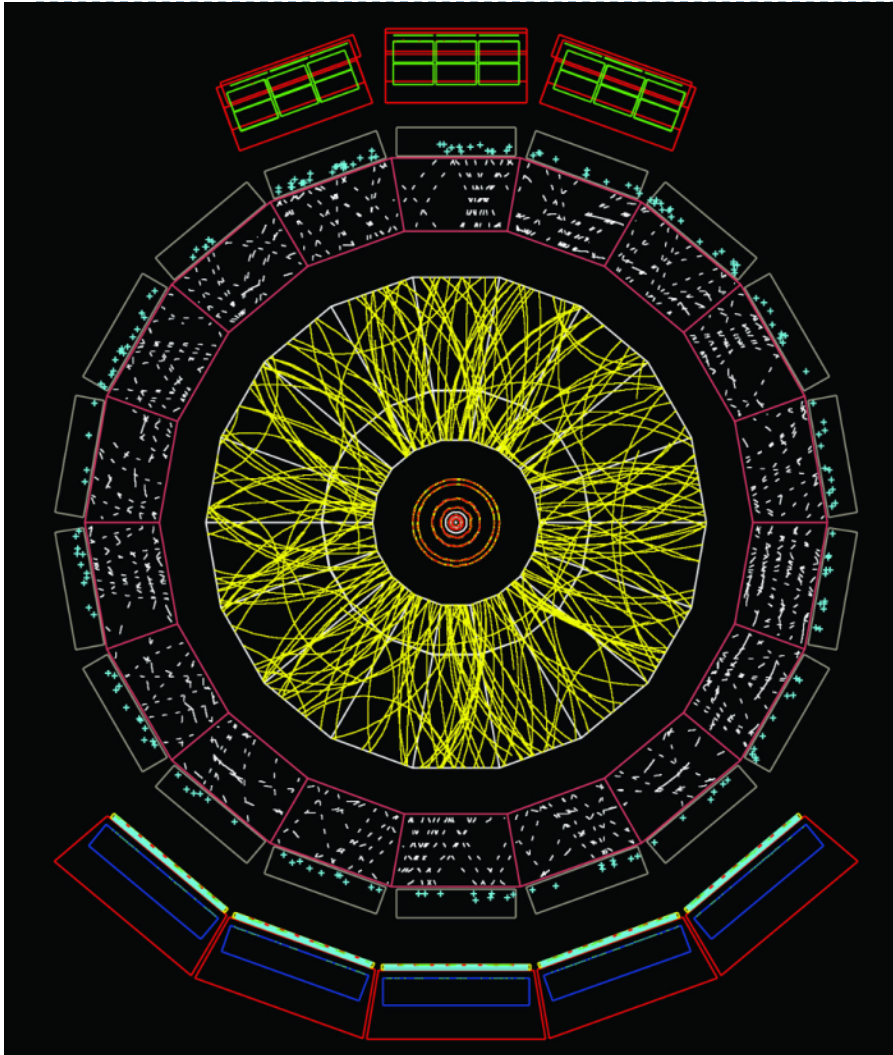

- ▶ 100,000 V on the cathode plane in the middle of the gas volume
- ▶ 32m² of detectors at the ends of the TPC
 - ▶ 570,000 channels
- ▶ The TPC will have to handle up to 40,000 tracks per event



Tracking - fin

- ▶ This ends our brief tour of the inner tracking devices
- ▶ Devices aim to have extremely good spatial resolution on the passage of ionising particles
 - ▶ Attempt to keep material low to
 - ▶ Give better tracking performance
 - ▶ Avoid too much energy loss from photons/electrons
- ▶ We will come back to discuss tracking detectors when we cover Muon detectors
- ▶ Next we will discuss how we catch the neutral particles which are created as well as trying to identify electrons

Outline

- ▶ What are the requirements for Detectors in HEP?
 - ▶ The physics requirements
 - ▶ Coping with the environment
- ▶ Particles passing through matter
- ▶ Tracking Detectors
- ▶ **Calorimetry**
- ▶ Muon Detection
- ▶ Detectors for triggering/timing/particle ID
- ▶ Preparing for the future - higher luminosity implications

Electron energy loss

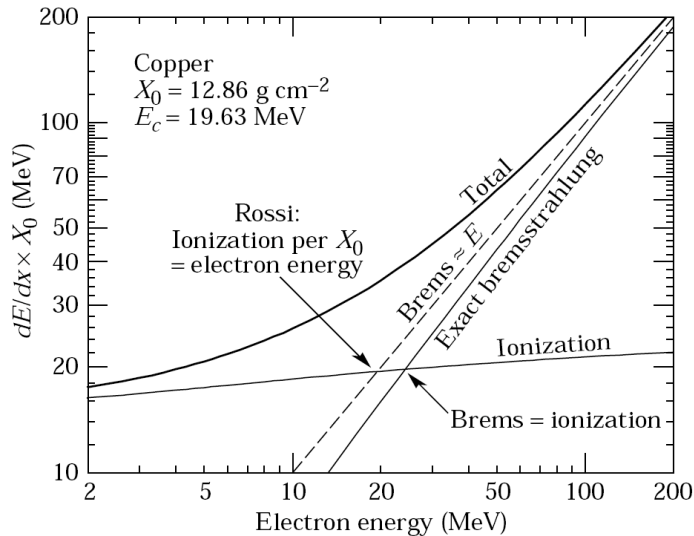
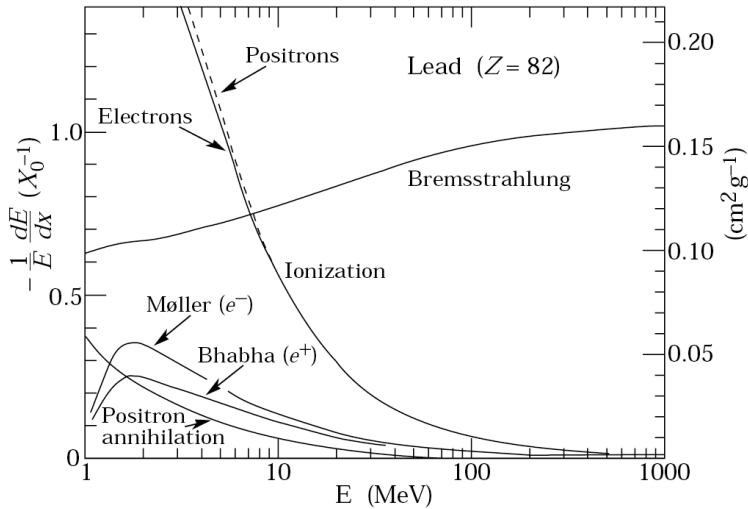

- ▶ Bremsstrahlung is the main mechanism for electron energy loss at energies above about 10 MeV
- ▶ (Compare 400 GeV for Muons)
- ▶ Critical Energy
- ▶ Where the ionization loss equals the loss from Bremsstrahlung

Photon Energy Loss

- ▶ For Photons, pair creation in the field of the nucleus is the dominant mechanism for energy loss at energies above an MeV.
- ▶ Compton scattering, then Rayleigh (and finally the photo-electric effect) dominate at lower energies

$$\sigma_{pair-creation} = \frac{7}{9} \frac{A}{N_A} \frac{1}{X_0}$$

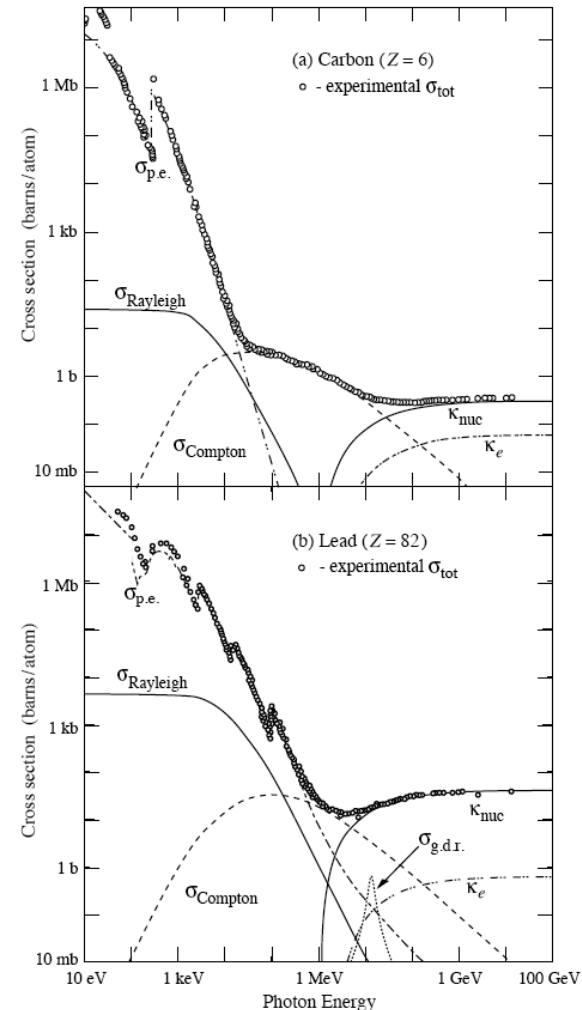

Electromagnetic Showers

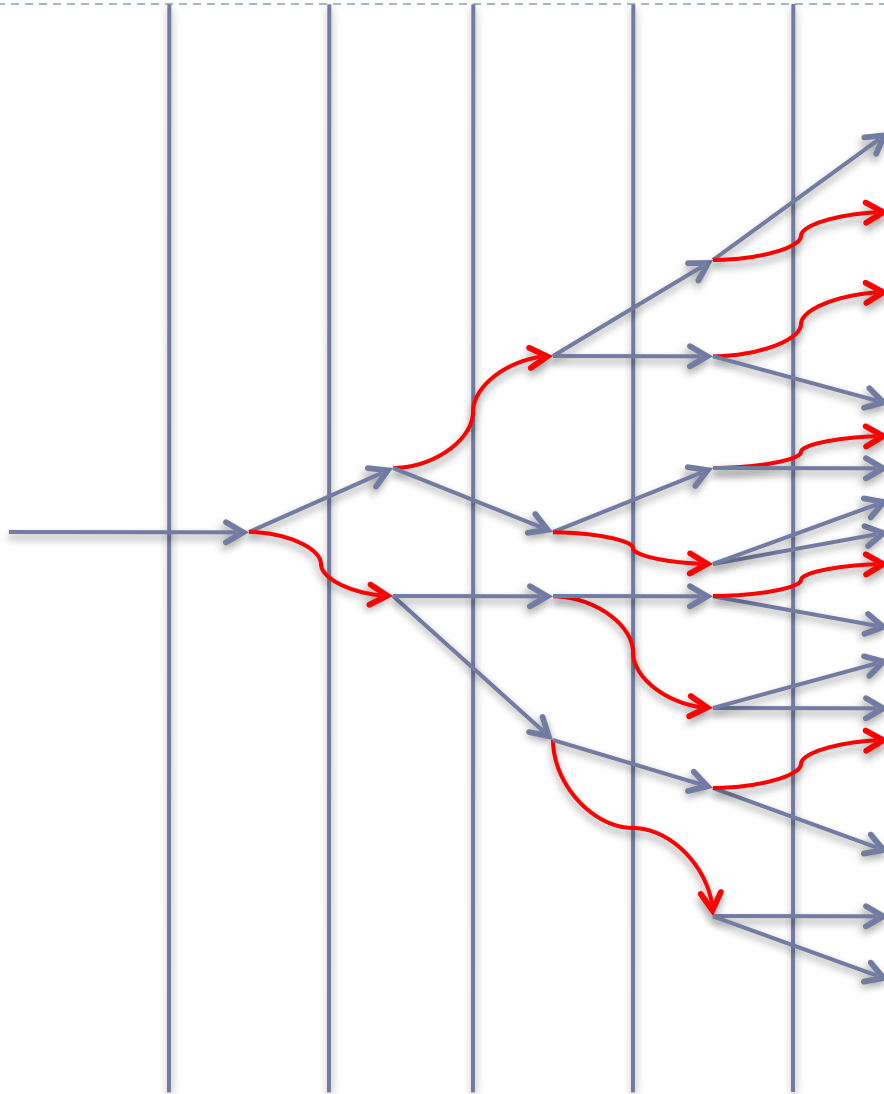

Each step t is about $1 X_0$

The Number of particles grows \sim as 2^t

Particle $E(t) \sim E_0/2^t$

When $E(t) < E_c$ the number of particles starts to decrease

The Shower Maximum occurs when $t \sim \ln(E_0/E_c)$

Electromagnetic Shower development

- ▶ Electromagnetic showers will deposit nearly all their energy within ~ 25 radiation lengths (at LHC energies)
 - ▶ Lower energy photons/electrons require much less depth
- ▶ Energy deposition tends to be relatively uniform for a given energy particle
 - ▶ Longitudinal and lateral shower profiles are clear signals of EM showers
- ▶ Lateral shower development characterized by the moliere radius
 - ▶ $R_m \sim 21 \text{ MeV } X_0/E_c$
 - ▶ Tends to be a few cm
 - ▶ EM showers are narrow

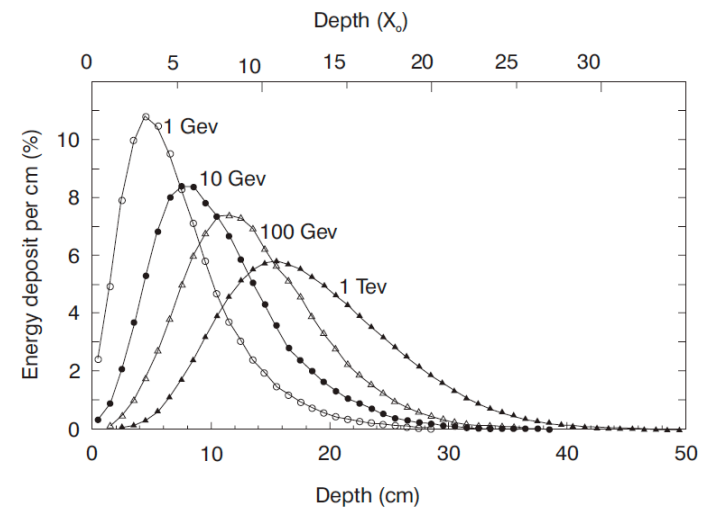
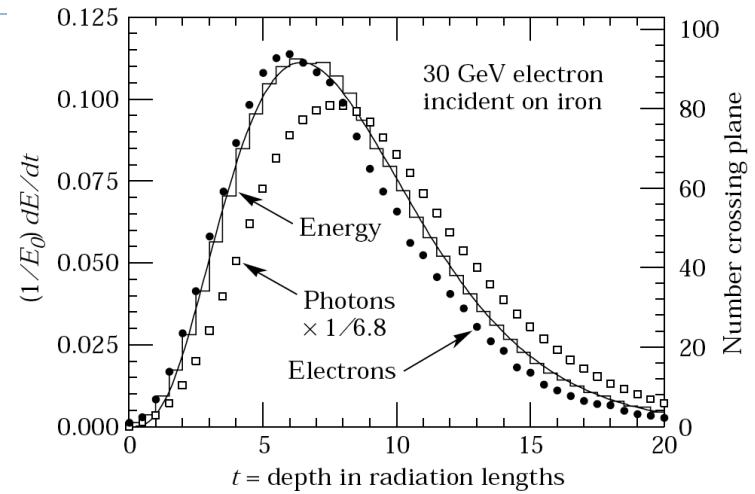

Hadronic Showers

- ▶ Most of the particles which come from the IP are pions
- ▶ π^0 's will decay to two photons which are then seen as EM showers
- ▶ Charged pions have a relatively small energy loss by ionization
- ▶ Hadrons however can undergo nuclear interactions
 - ▶ About 1/3 of these will produce π^0 's which then are quickly absorbed
 - ▶ Secondary charged pions can undergo further interactions which causes the EM fraction to rise for higher energy hadrons
 - ▶ Can also knock out protons which are more heavily ionizing
 - ▶ Energy can be *lost* in breaking up bound Nuclei
- ▶ Hadronic calorimeters have intrinsically non-linear responses to hadron energy

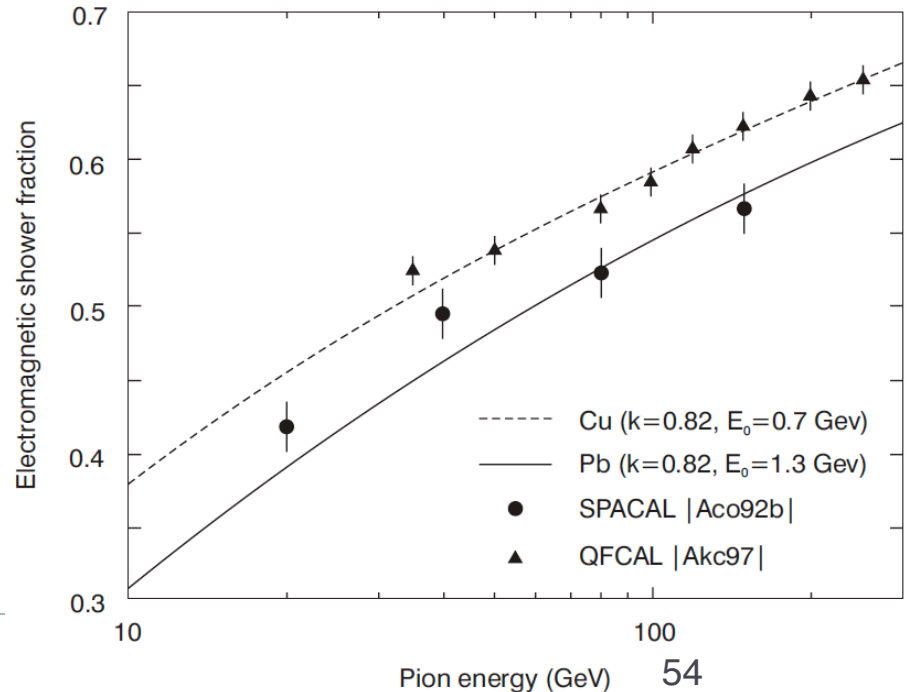
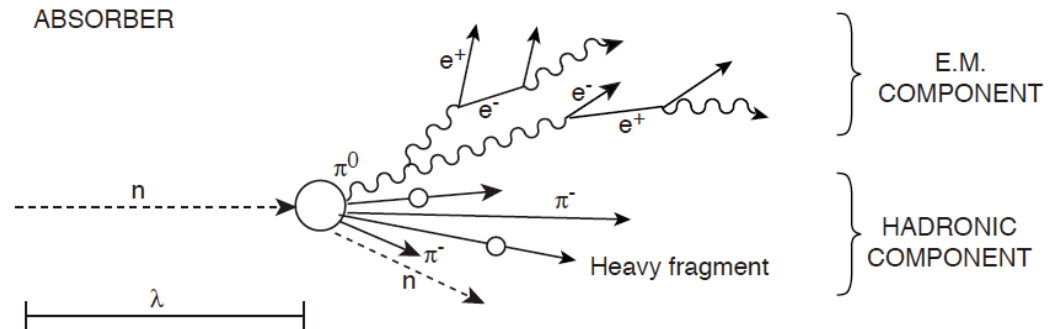

Interaction Length

| | Z | ρ g.cm ⁻³ | I/Z eV | (1/ ρ)dT/dx MeV/g.cm ⁻³ | ϵ MeV | X ₀ cm | λ_{int} cm |
|----|----|------------------------------|-----------|---------------------------------------------|-------------------|----------------------|------------------------------|
| C | 6 | 2.2 | 12.3 | 1.85 | 103 | ≈ 19 | 38.1 |
| Al | 13 | 2.7 | 12.3 | 1.63 | 47 | 8.9 | 39.4 |
| Fe | 26 | 7.87 | 10.7 | 1.49 | 24 | 1.76 | 16.8 |
| Cu | 29 | 8.96 | | 1.40 | ≈ 20 | 1.43 | 15.1 |
| W | 74 | 19.3 | | 1.14 | ≈ 8.1 | 0.35 | 9.6 |
| Pb | 82 | 11.35 | 10.0 | 1.14 | 6.9 | 0.56 | 17.1 |
| U | 92 | 18.7 | 9.56 | 1.10 | 6.2 | 0.32 | 10.5 |

- ▶ Characteristic length over which a hadronic interaction will occur is λ similar to the radiation length for EM showers
- ▶ Interaction lengths tend to be much longer than radiation length for the same material
- ▶ Hadronic showers are much less uniform in their development than electromagnetic showers

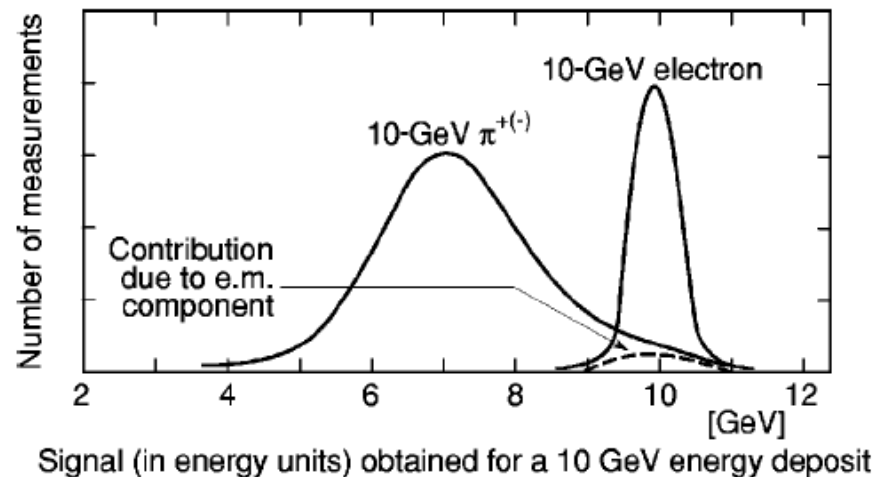

Hadronic shower development

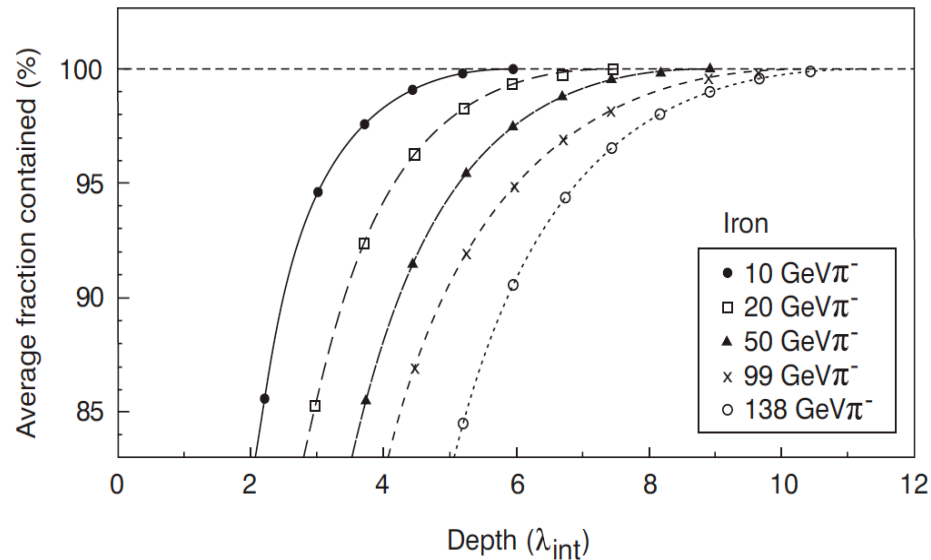

- ▶ Hadron energy mostly contained in 8-10 interaction lengths
- ▶ Note λ in Iron is ~ 17 cm
- ▶ Shower profiles are very non-uniform

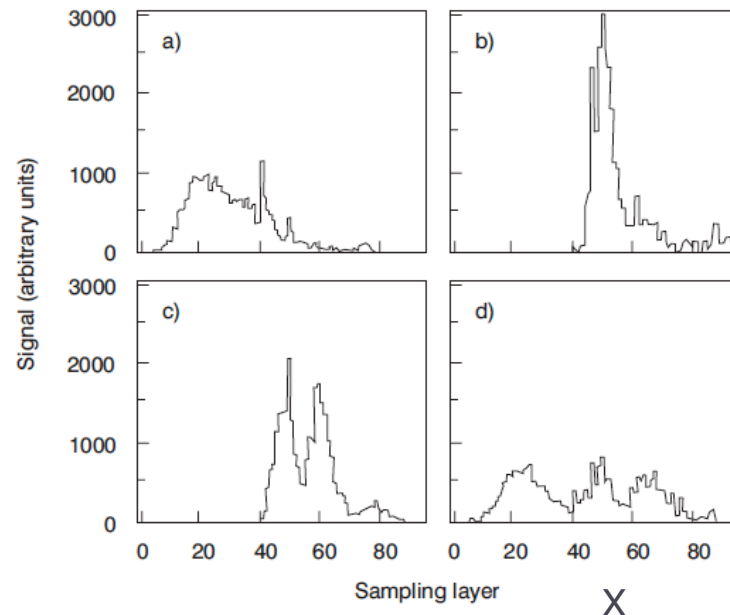

Calorimetric measurements

Sampling Calorimeters

Mix layers which can detect energy deposited and passive layers which act as absorbers. Not all energy is detected

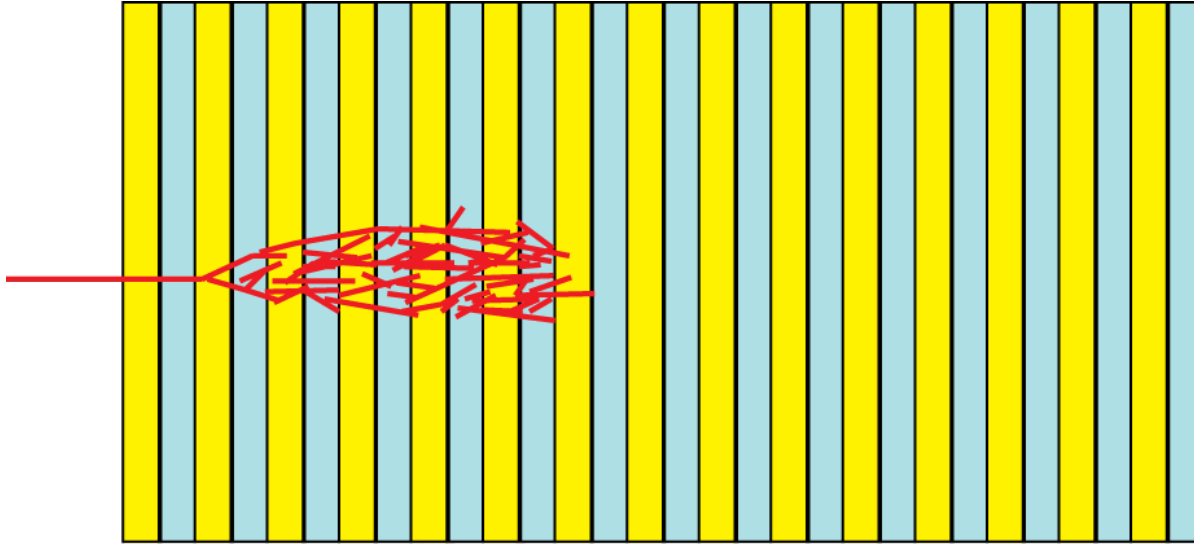

Homogenous Calorimeters

Absorber material is also the detecting material

All energy deposited in the calorimeter is detected

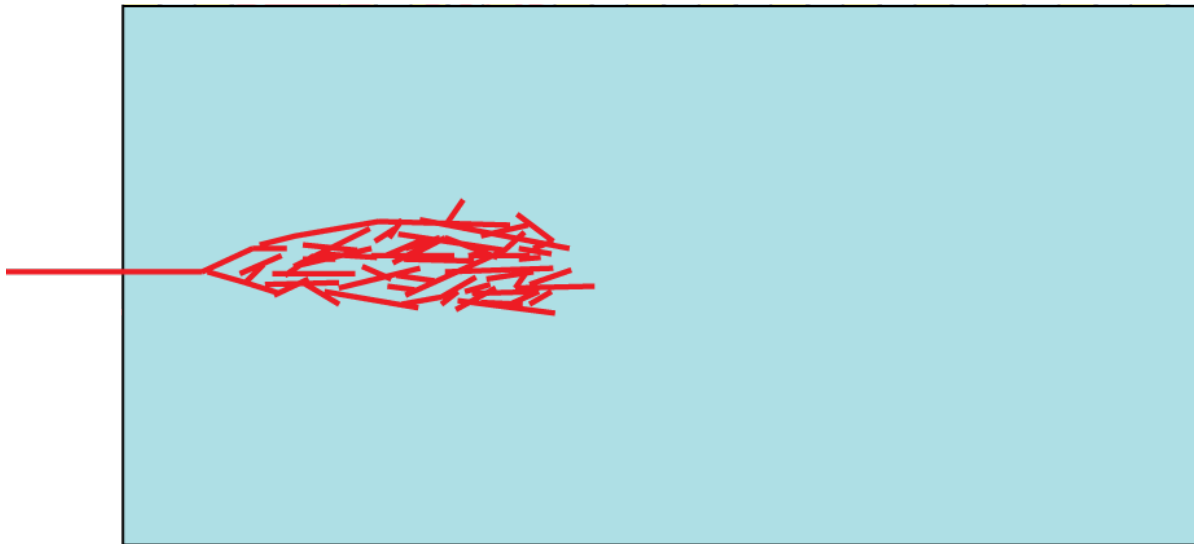

Comparing Sampling and Homogenous calorimeter performance

$$\frac{\sigma}{E} = \frac{a}{\sqrt{E}} \otimes \frac{b}{E} \otimes c$$

Stochastic Term – Depends on Signal fluctuations

Noise Term – determined by the electronics noise in the system and background “noise”

Constant Term – determined by the construction of the system – leakage of energy calibration errors, non-linearity

| | Z | ρ g.cm ⁻³ | I/Z eV | (1/ ρ)dT/dx MeV/g.cm ⁻³ | ϵ MeV | X ₀ cm | λ_{int} cm |
|----|----|------------------------------|-----------|---------------------------------------------|-------------------|----------------------|------------------------------|
| C | 6 | 2.2 | 12.3 | 1.85 | 103 | ≈ 19 | 38.1 |
| Al | 13 | 2.7 | 12.3 | 1.63 | 47 | 8.9 | 39.4 |
| Fe | 26 | 7.87 | 10.7 | 1.49 | 24 | 1.76 | 16.8 |
| Cu | 29 | 8.96 | | 1.40 | ≈ 20 | 1.43 | 15.1 |
| W | 74 | 19.3 | | 1.14 | ≈ 8.1 | 0.35 | 9.6 |
| Pb | 82 | 11.35 | 10.0 | 1.14 | 6.9 | 0.56 | 17.1 |
| U | 92 | 18.7 | 9.56 | 1.10 | 6.2 | 0.32 | 10.5 |

$$\frac{\sigma_s}{E} = \frac{5\%}{\sqrt{E}} (1 - f_{\text{samp}}) \Delta E_{\text{cell}}^{0.5(1-f_{\text{samp}})}$$

$$f_{\text{samp}} = 0.6 f_{\text{mip}} = 0.6 \frac{d \left(\frac{dE}{dx} \right)_{\text{act}}}{\left[d \left(\frac{dE}{dx} \right)_{\text{act}} + t_{\text{abs}} \left(\frac{dE}{dx} \right)_{\text{abs}} \right]}$$

Sampling calorimeters will have a larger stochastic term, and they measure only a fraction of the energy deposited in the calorimeter

CMS Crystal EM calorimeter

- ▶ Crystal calorimeters absorb all EM shower energy and re-emit as scintillation photons
- ▶ Photons are collected at the ends of the crystal
- ▶ For LHC require crystal with fast response, high density, tolerance to high radiation levels
 - ▶ Lead Tungstate was chosen
- ▶ Crystals are cut to be about $1 R_m$ in size
 - ▶ EM energy is contained in only a few crystals
 - ▶ >95% in 9 crystals
 - ▶ Can cluster up to 25 crystals to try to catch all the shower energy
 - ▶ Search for small dense clusters of energy in the crystals
 - ▶ Can separate EM from Hadronic showers

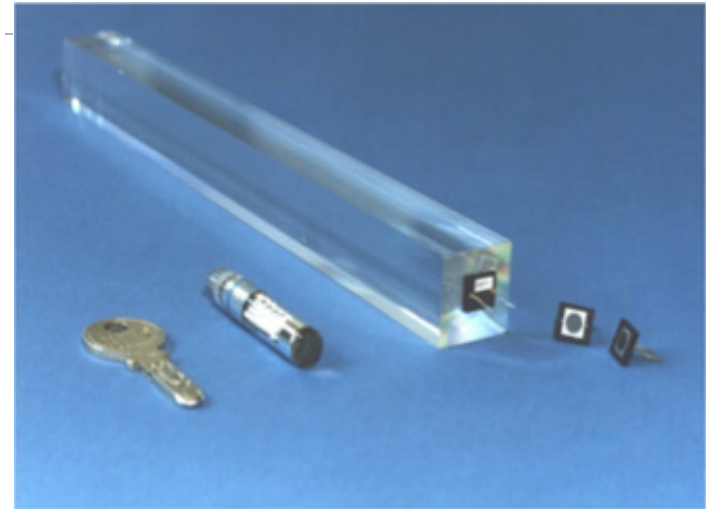

| property | NaI(Tl) | BGO | CsI(Tl) | PbWO ₄ |
|--------------------------|---------|------|---------|-------------------|
| Density ($g\ cm^{-3}$) | 3.67 | 7.13 | 4.53 | 8.28 |
| X_0 (cm) | 2.59 | 1.12 | 1.85 | 0.89 |
| R_m (cm) | 4.5 | 2.4 | 3.8 | 2.2 |
| Decay Time (ns) | 250 | 300 | 1000 | 10 |
| Rel. Light Output | 1.00 | 0.15 | 0.40 | 0.01 |



Calorimeter Construction

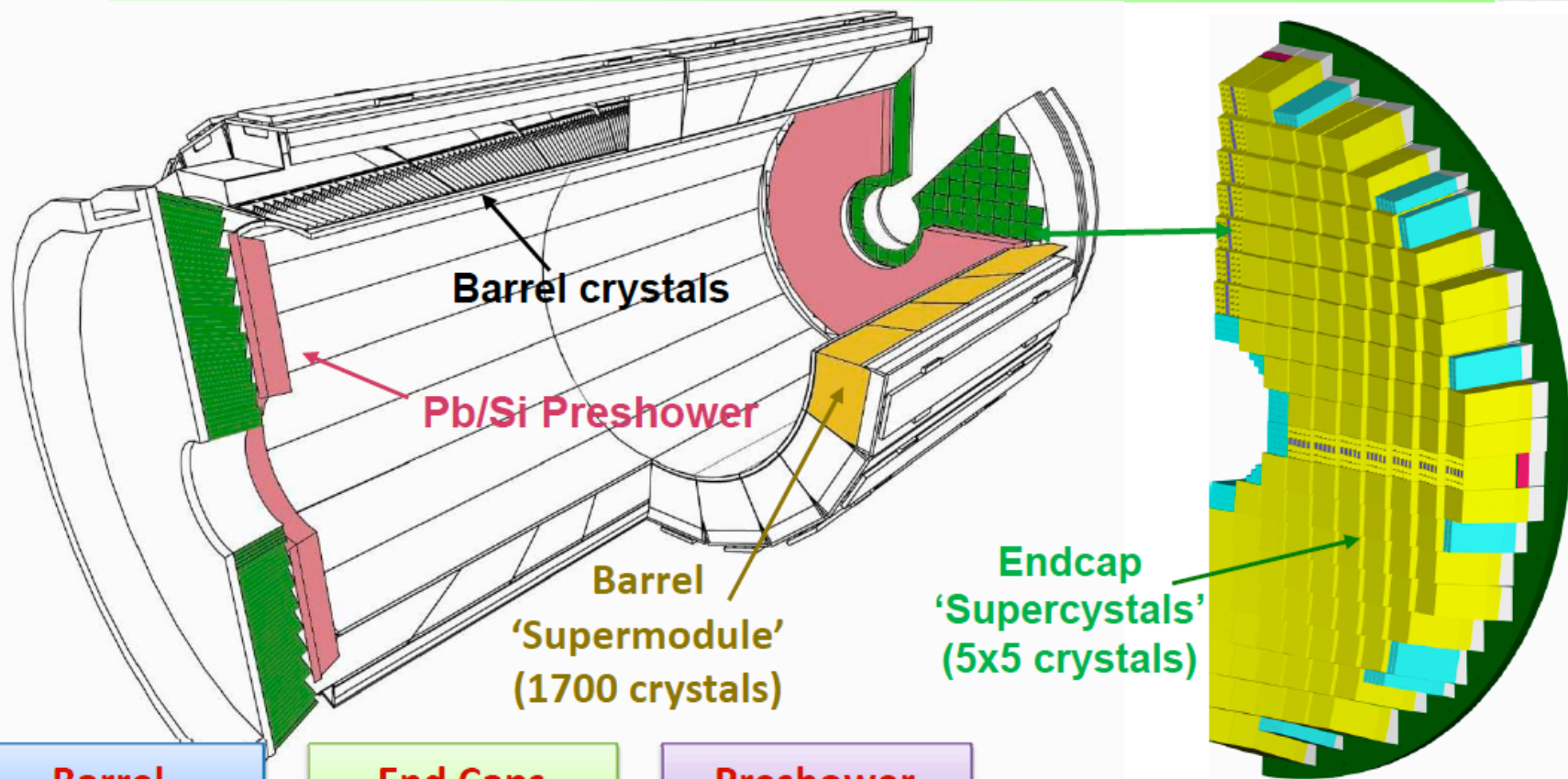

Barrel

- 61200 crystals
- 36 super modules
- $|\eta| < 1.48$
- $\sim 26 X_0$

End Caps

- 14648 crystals
- 4 Dees
- $1.48 < |\eta| < 3$
- $\sim 25 X_0$

Preshower

- Pb/Si
- $1.65 < |\eta| < 2.6$
- $3 X_0$

Life time: • **~10 years**

Maintenance: • **zero**

Performance of Crystal Calorimeter

- ▶ Crystal Calorimeters deliver extremely good energy resolution
- ▶ Need to control many things to achieve the best resolution
 - ▶ dead material between crystals
 - ▶ Electronics noise
 - ▶ Temperature stability
 - ▶ ...
- ▶ Difficult to get longitudinal shower information

Fluctuations in the shower development and in the measurement of the shower properties dominate the resolution

$$\frac{\sigma_E}{E} = \frac{A}{\sqrt{E}} \oplus \frac{B}{E} \oplus C$$

- A (Stochastic) comes from sampling fluctuations
- B (Noise) comes from Electronics and Beam Noise
- C (Constant) comes from Non-uniformity, Calibration errors, shower leakage

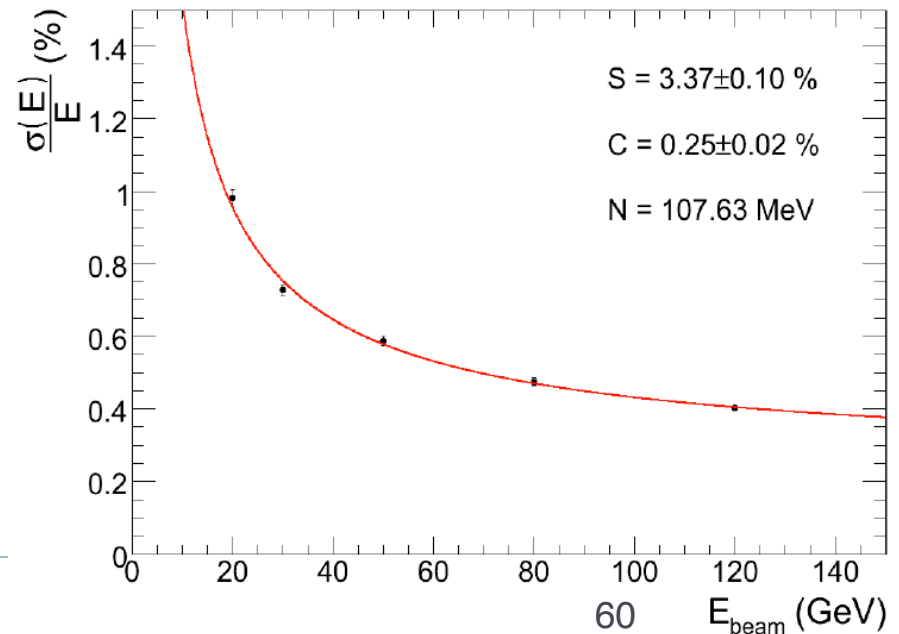

CMS ECAL photo detector

- ▶ 80,000 channels of lead tungstate crystal
 - ▶ Low light yield - Around 5 pe/MeV
- ▶ Avalanche PhotoDiode used in Ecal Barrel
 - ▶ Gain 50
- ▶ Vacuum Photo Triode used in Ecal Endcap
 - ▶ Lower gain
 - ▶ Can withstand high magnetic fields in EE
- ▶ To achieve the energy resolution electronics needs to have
 - ▶ Low noise
 - ▶ 50 MeV (8000 e-)
 - ▶ High dynamic range

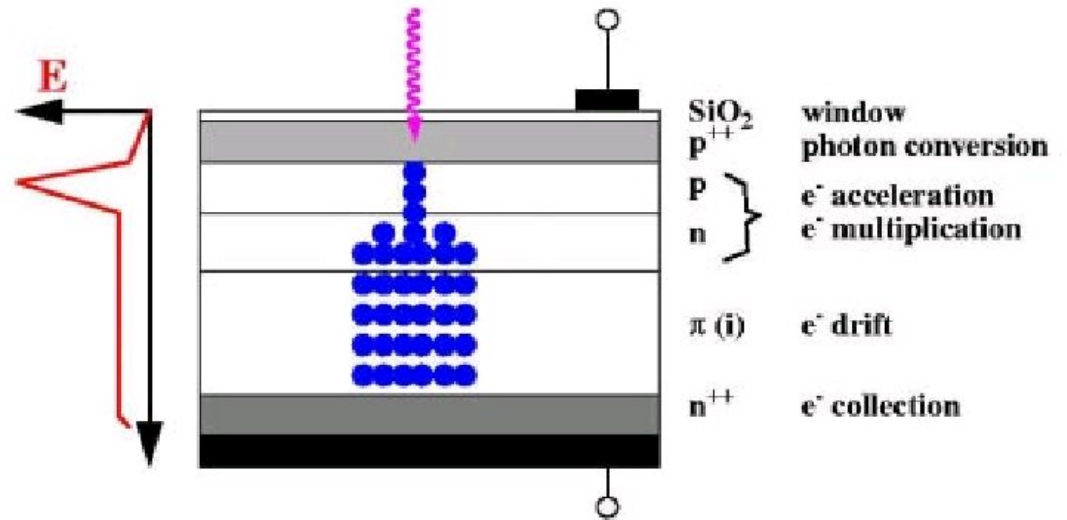
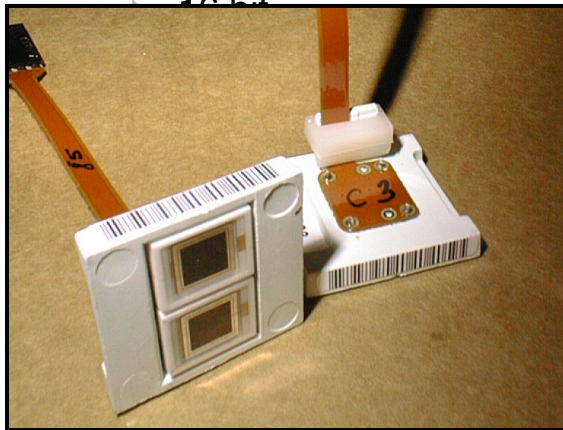
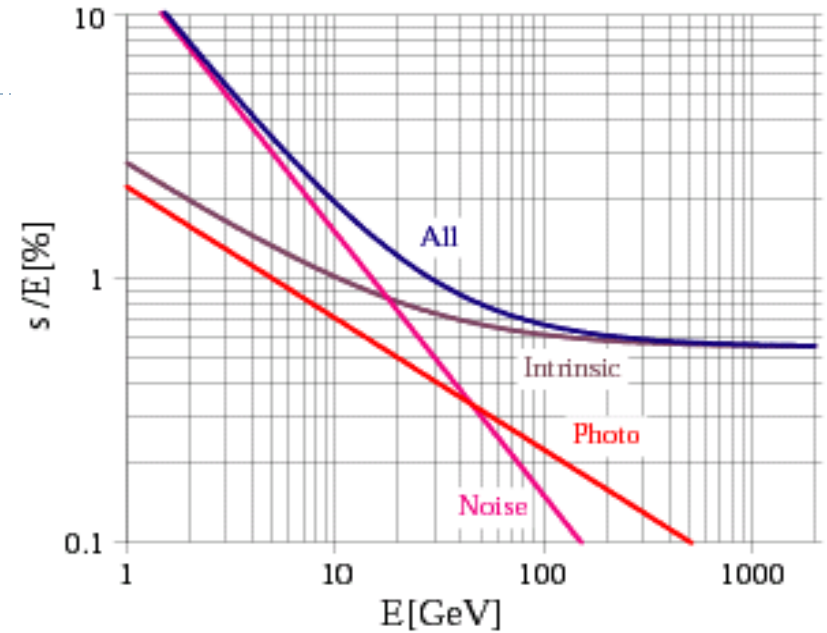

Ecal Very Front End

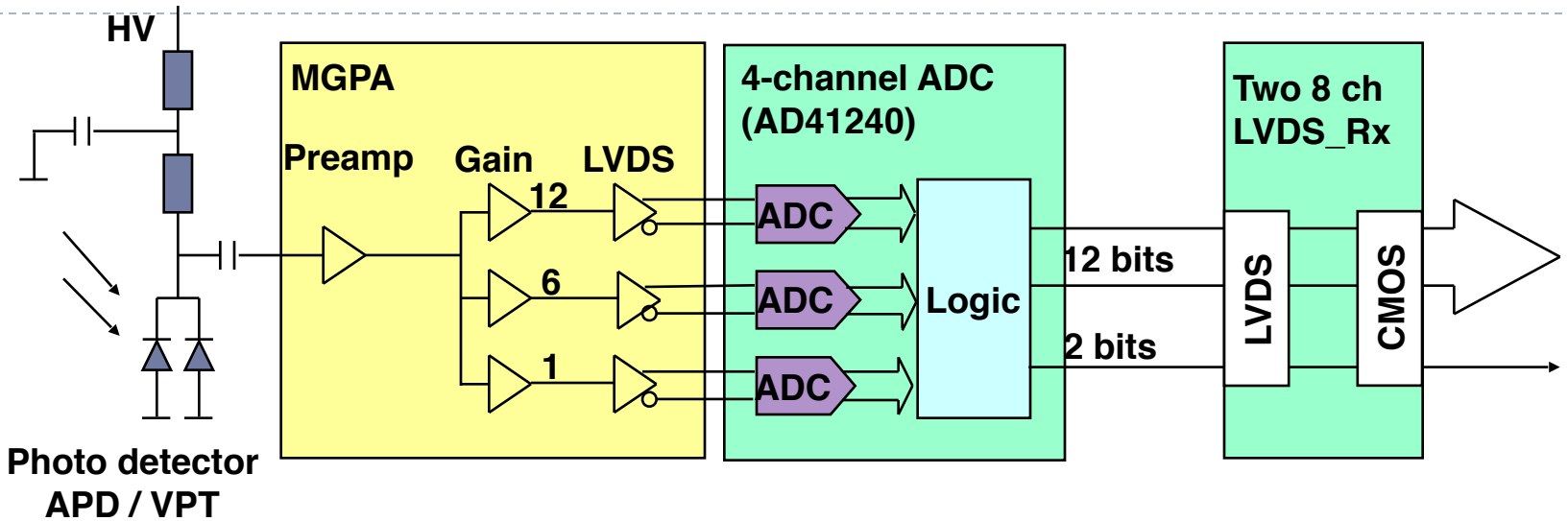

- ▶ Dynamic range achieved using multi-gain system
- ▶ Three parallel digitization stages
- ▶ Digital selection of highest gain non-saturated stage
- ▶ Two new custom ASICs in 0.25 μm CMOS

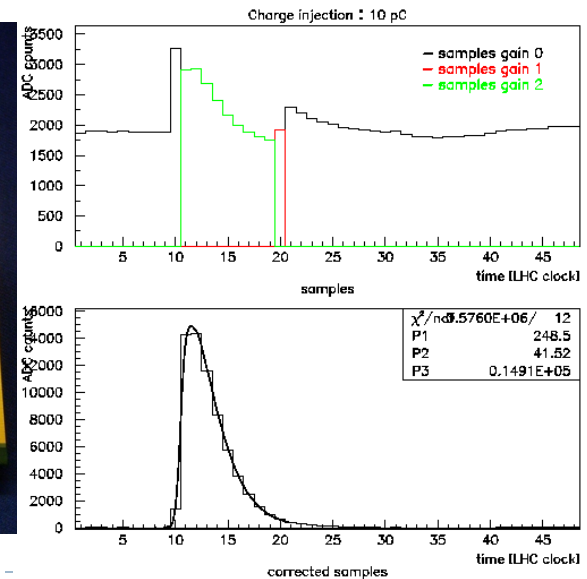
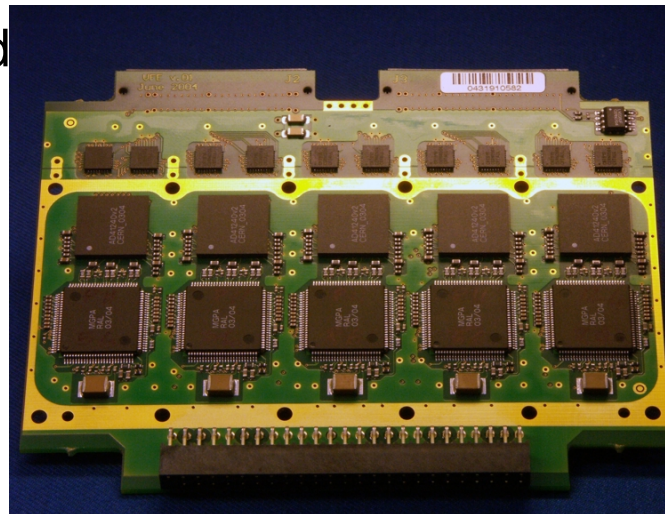

ATLAS Calorimetry

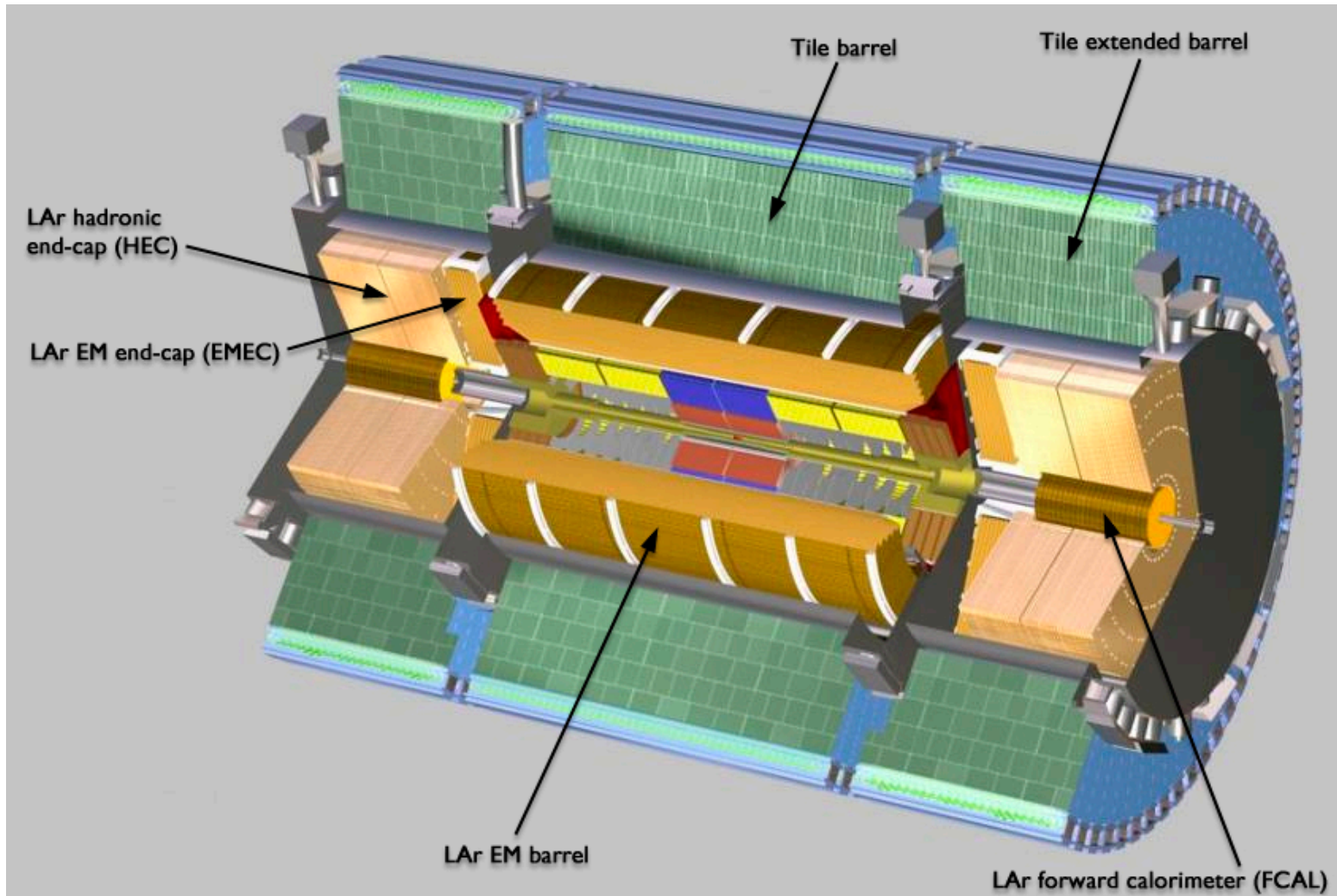

ATLAS Liquid Argon Sampling Calorimeter

- ▶ Stacks of Lead (1-2mm) with Liquid Argon gaps of about 4mm in between the lead plates
 - ▶ Lead X_0 about 5.5 mm
 - ▶ Liquid Ar X_0 14 cm
 - ▶ 24 X_0 of lead/LAr
- ▶ EM Showers in lead, electrons ionize the LAr and leave a signal which is proportional to the energy deposited
 - ▶ Deposited charge is large so no charge multiplication is needed
- ▶ Accordion design to avoid dead areas, and cables running through the detection volume
- ▶ Resolution is slightly worse than crystals due to sampling fluctuations
 - ▶ 10% vs 3% Stochastic Term

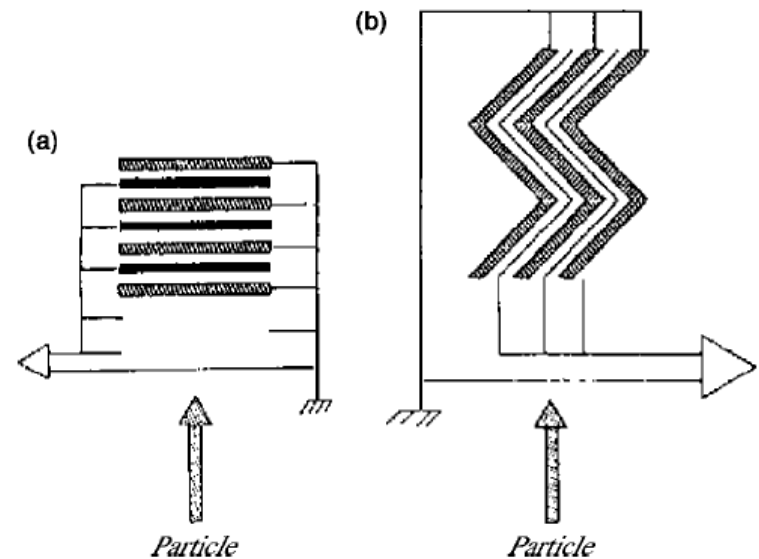
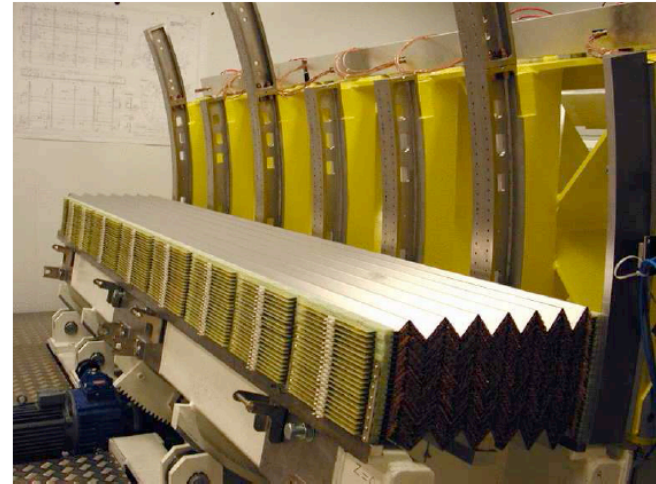
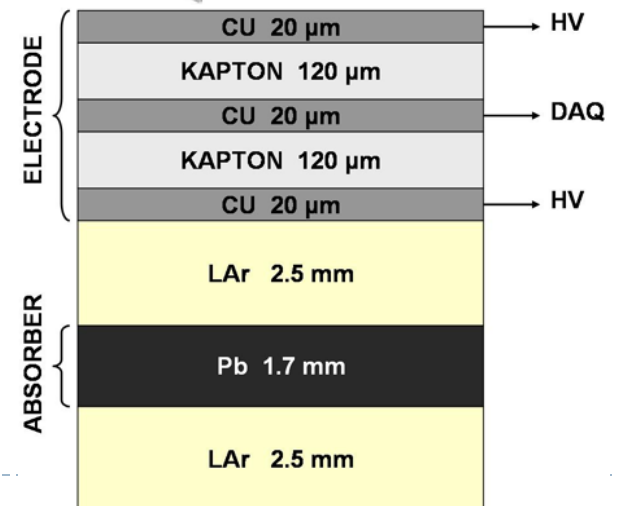
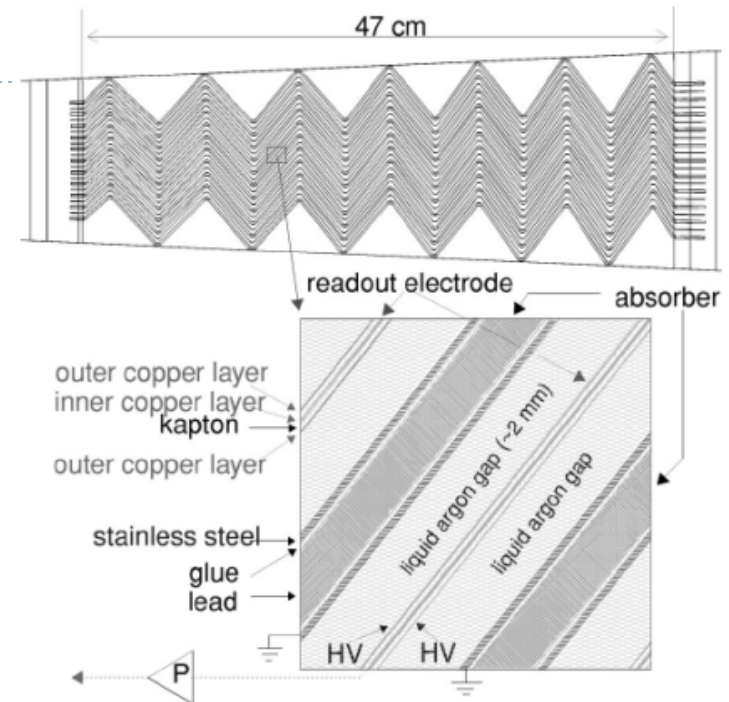
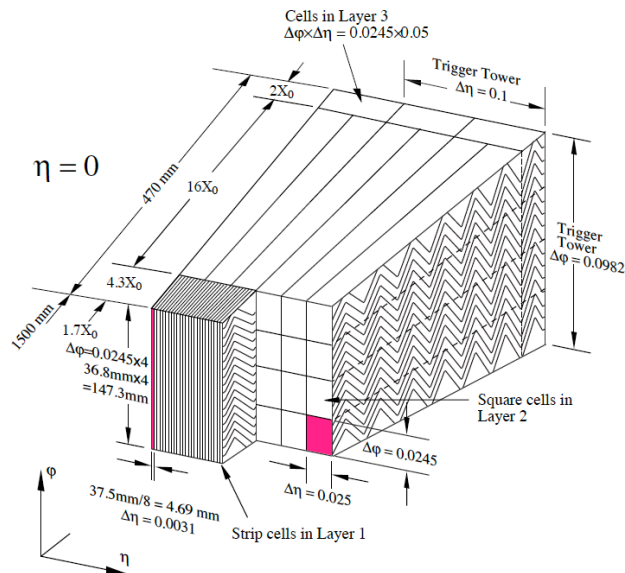
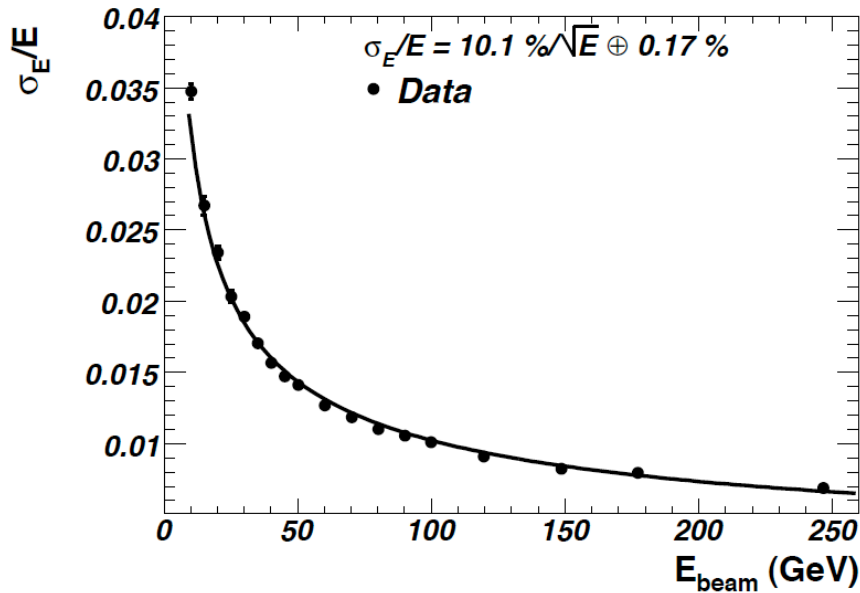
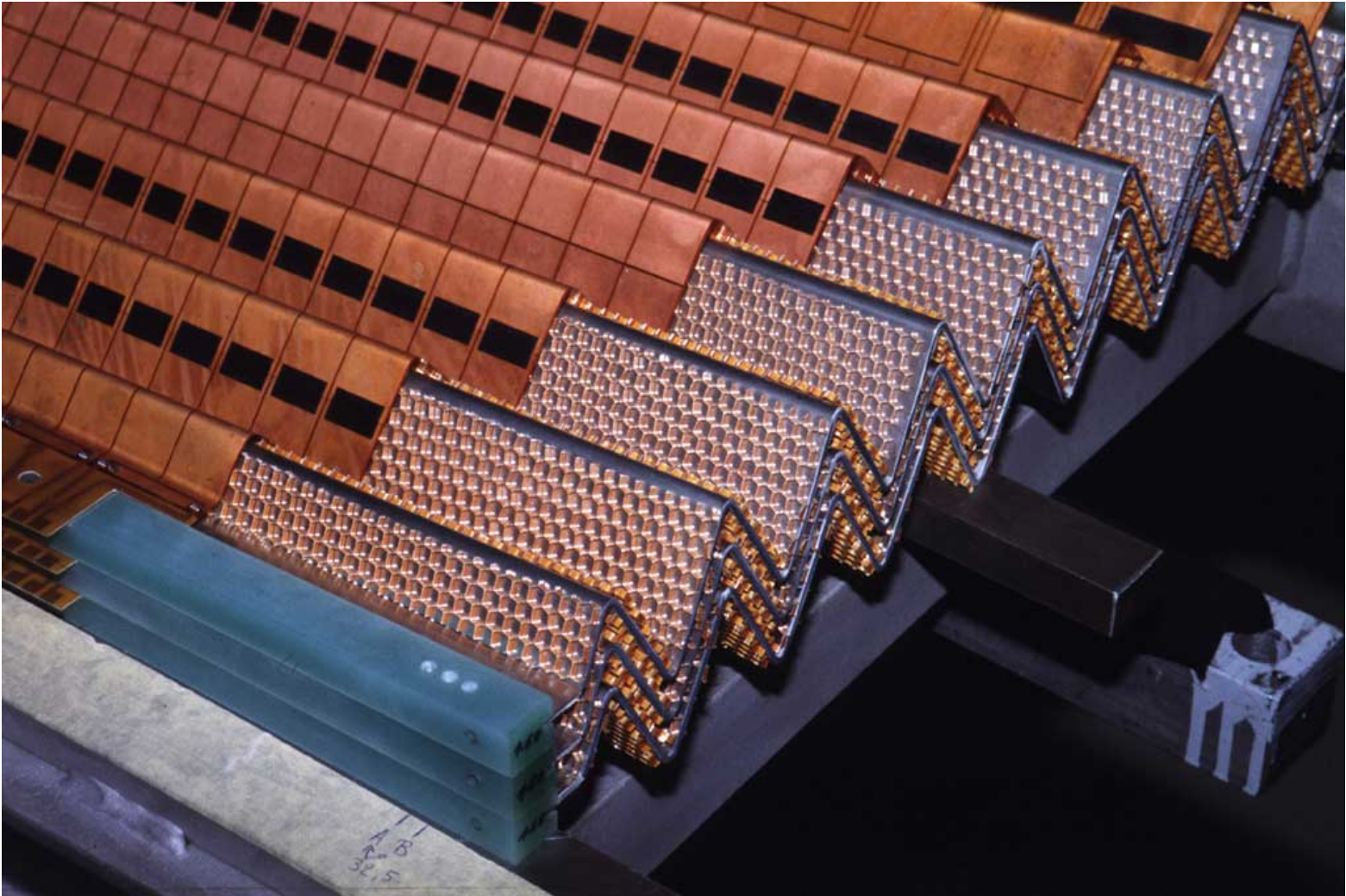

FIG. 15. Schematic view of a traditional sampling calorimeter geometry (a) and of the accordion calorimeter geometry (b).

ATLAS EM Module "Accordion"



Accordion



ATLAS Tile Hadronic calorimeter

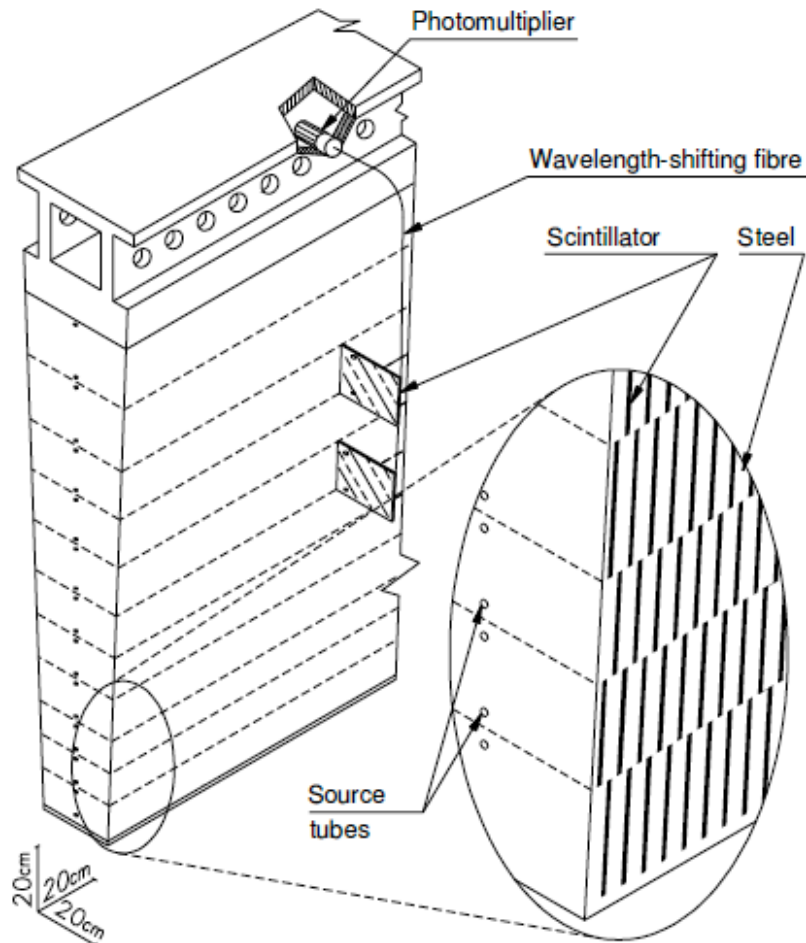

- ▶ Iron/Scintillator sampling calorimeter
- ▶ Scintillator photon signals routed out on fibres
- ▶ Fibres bundled together in three regions of depth
 - ▶ Gives ability to look at the longitudinal profile of the hadronic shower
- ▶ >7.4 Interaction lengths of material

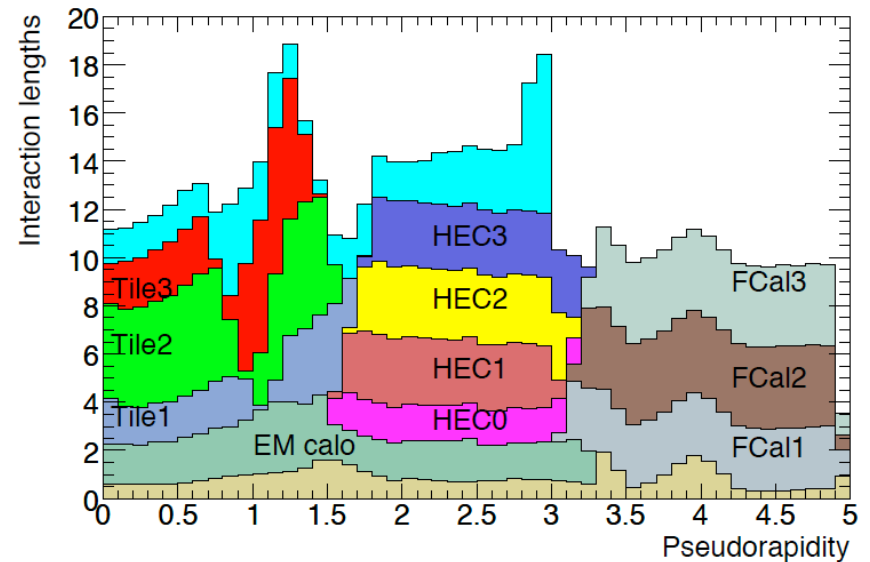

Fibre routing for the ATLAS Tile Cal

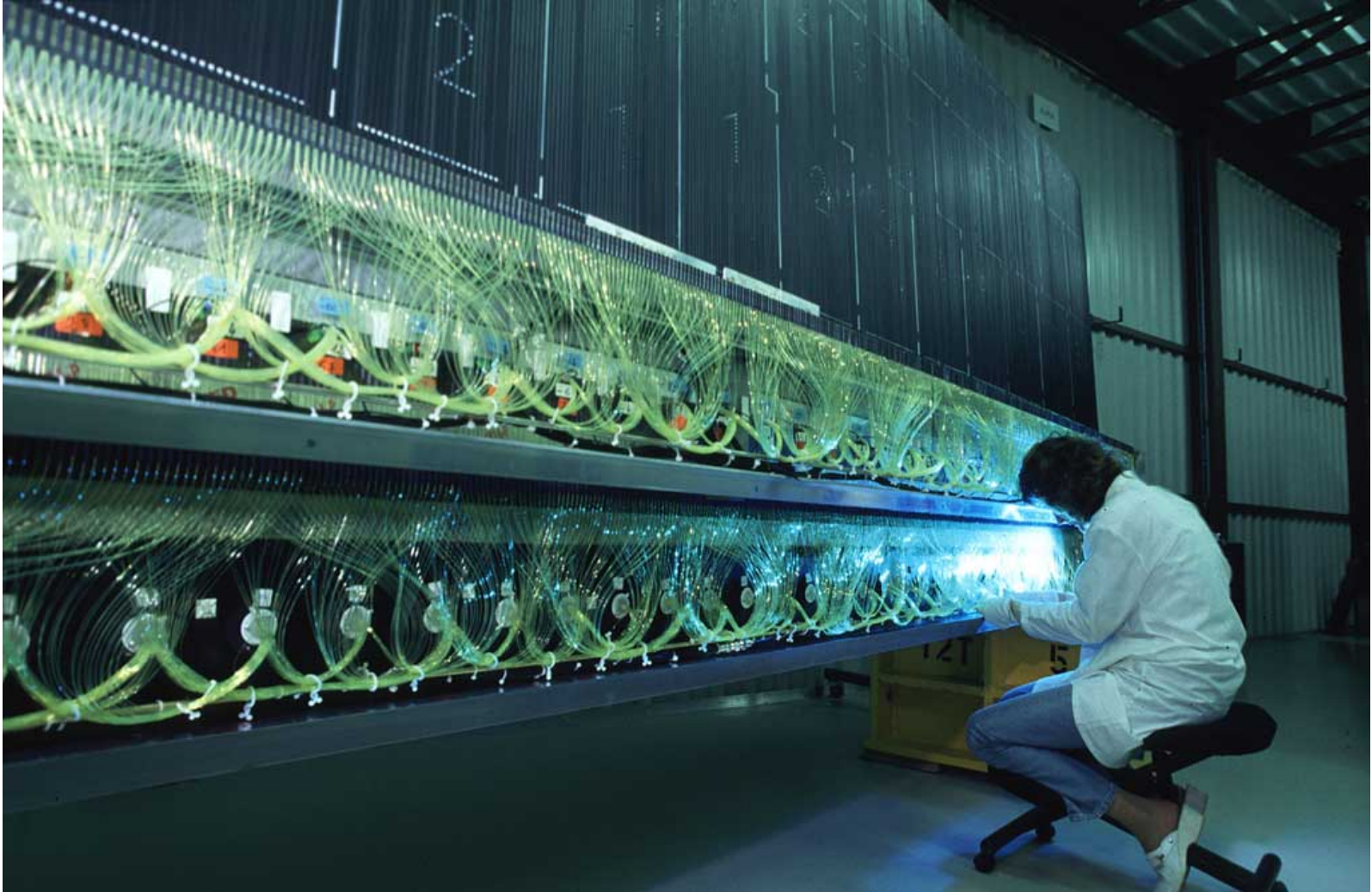

Tile Cal Readout Photo Multiplier Tube

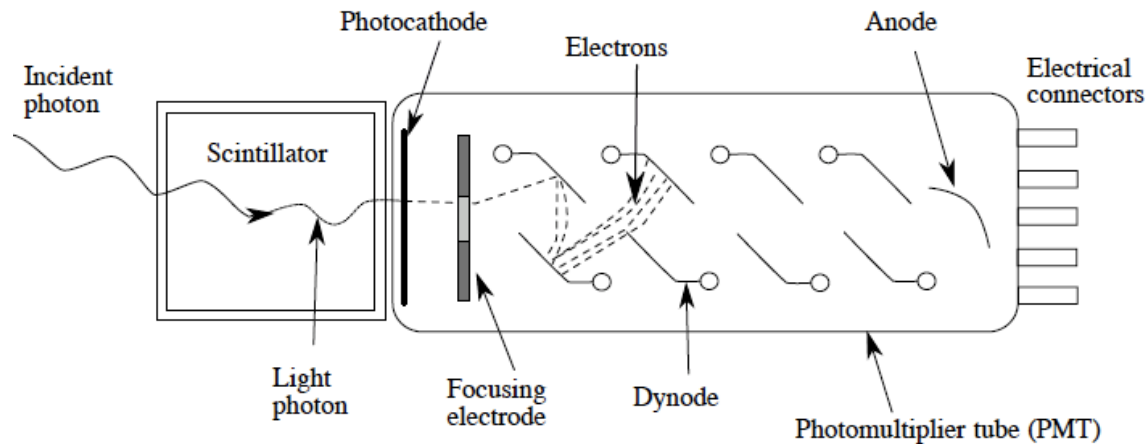

- ▶ Scintillator signals are typically a small number of photons emitted for a minimum ionizing particle
 - ▶ Traditional detector for small number of photons is the Photo Multiplier
 - ▶ Initial photon strikes a photocathode and emits electrons
 - ▶ These are then amplified in a cascade of dynodes
 - ▶ There is a potential between each dynode pair with accelerates the electrons
 - ▶ Much larger amount of charge appears at the Anode can even detect single photons
 - ▶ Trade-offs
-
- ▶ x▶ Can be fairly large, and not easy to use in a magnetic field

TileCal Performance

Resolutions for Hadron calorimeters is clearly not as precise as for EM calorimeters

The stochastic term dominates, the sampling fraction, and the “lost” energy mean resolutions in the region of 50-100%/sqrt(E)

They are much more difficult devices to make precision energy measurement with

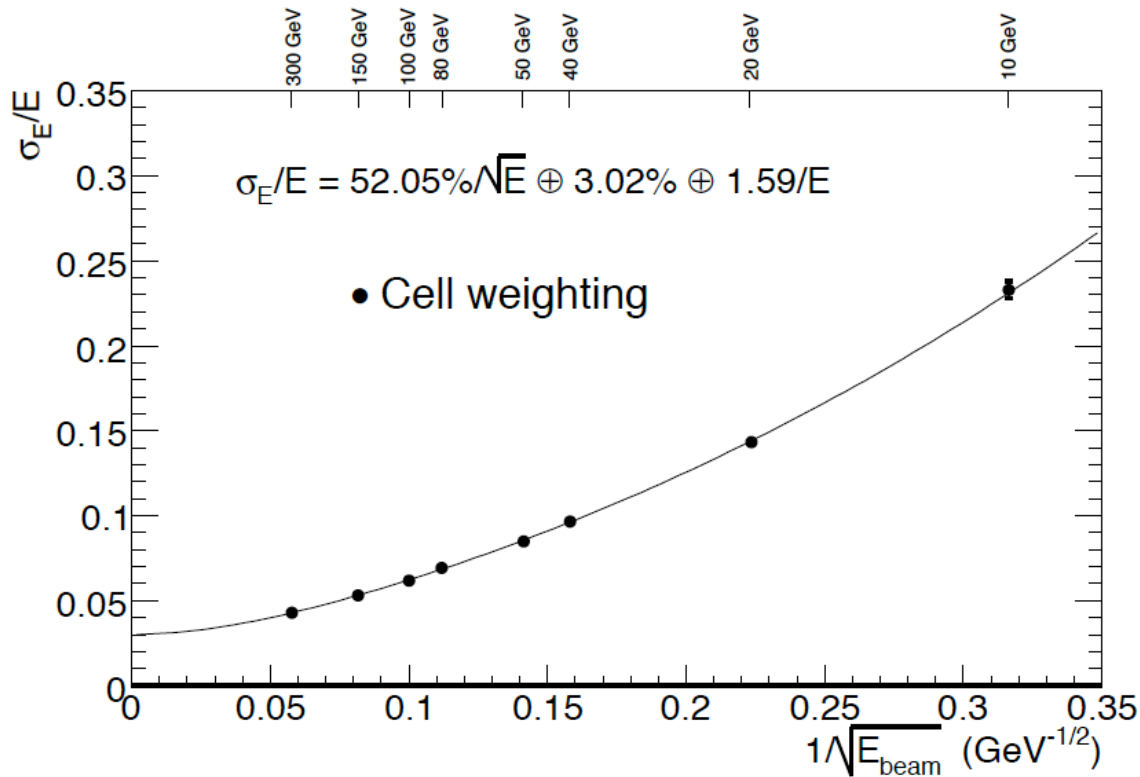

CMS Calorimeters overview

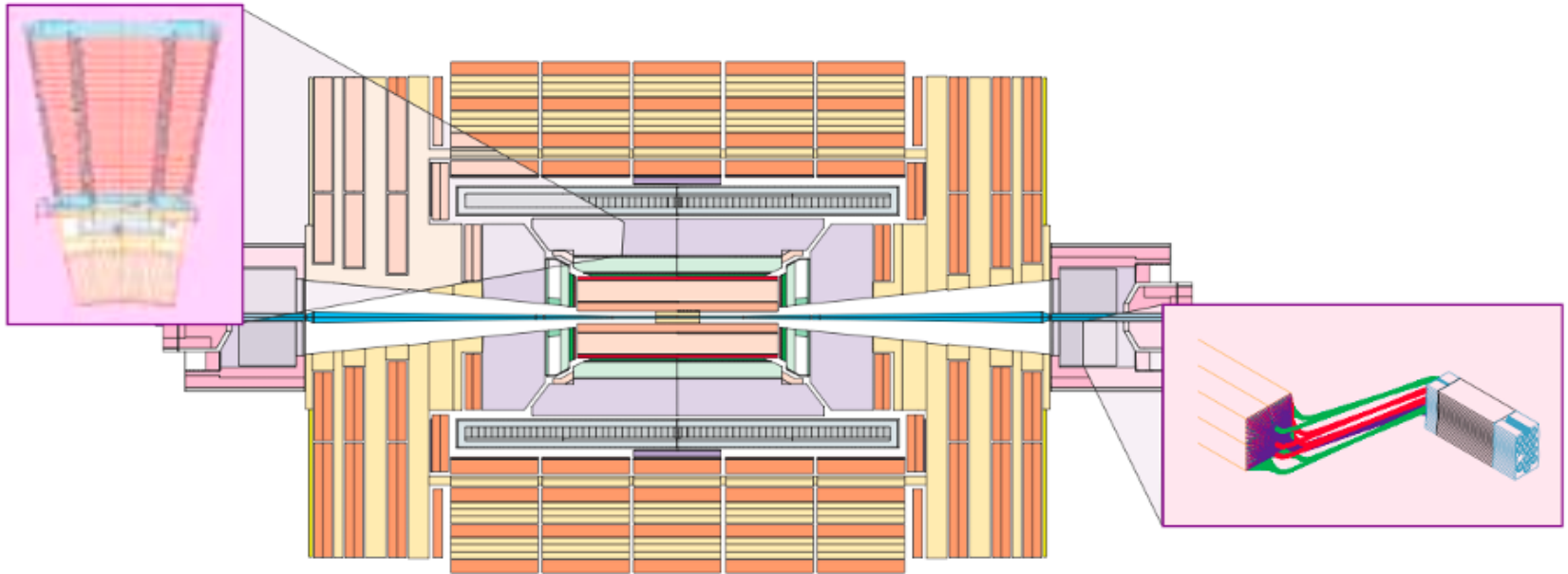

- ▶ We want calorimeters to be
- ▶ Hermetic
 - ▶ Important when we are searching for missing energy signatures – These are determined by summing up all the energy we see in the calorimeters and seeing where Energy doesn't balance
 - ▶ Instrumental effects can cause us to mistakenly think we have missing energy
- ▶ Have the best possible position and energy resolution
 - ▶ The better we measure the energy, the better job we do at understanding the physics process which produced the jets/leptons we are measuring
- ▶ However they need to be very large, and have to be built at finite cost (time/money)

Projective Geometry of calorimeters

Calorimeters are designed to be projective in eta.

Energy which is emitted along a direction coming from the interaction point is captured in a “tower”

Data is summed over a tower – This reduces the number of readout channels, and also allows the energy in a jet to be determined (for trigger purposes for example)

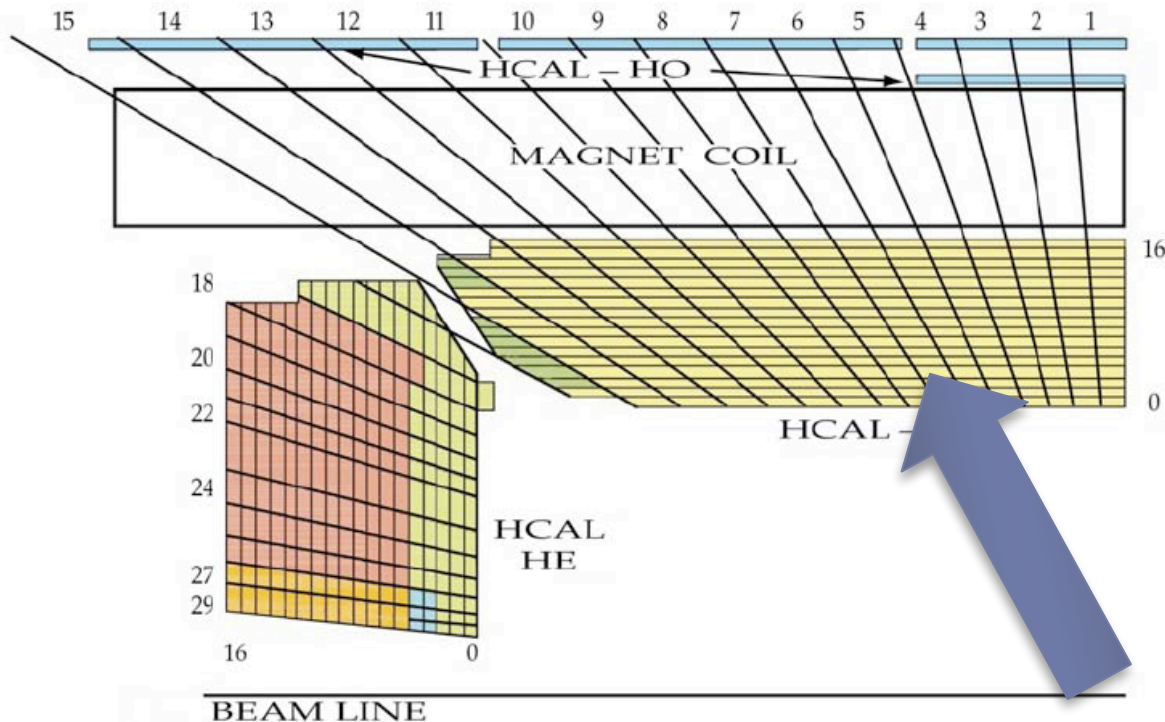

CMS HCAL

- ▶ Brass-Scintillator sandwich
 - ▶ Brass from old Russian army shells
- ▶ About 10,000 Channels in the system
- ▶ Signal is light in scintillator
 - ▶ Summing over depth of calorimeter done optically by bundling fibres
- ▶ Large dynamic range needed
 - ▶ Must be able to see signals

| | |
|----------------------|------------------------|
| chemical composition | 70% Cu, 30% Zn |
| density | 8.53 g/cm ³ |
| radiation length | 1.49 cm |
| interaction length | 16.42 cm |

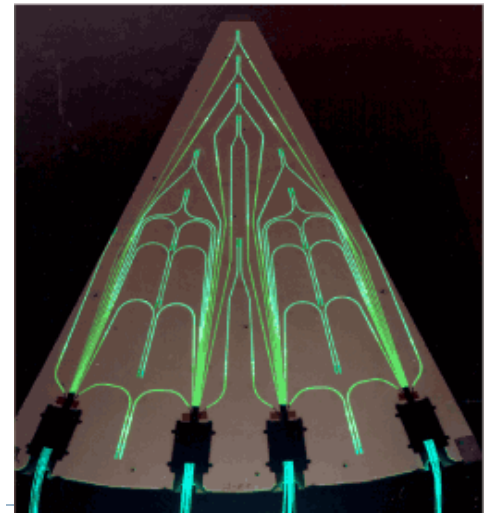
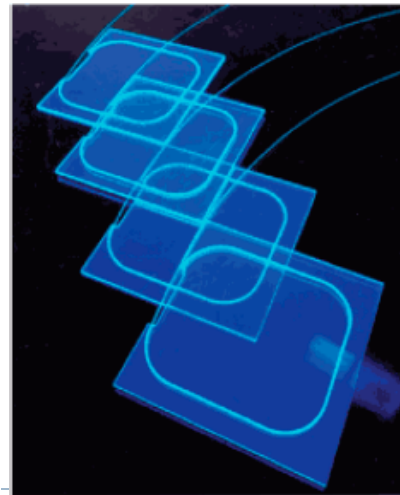
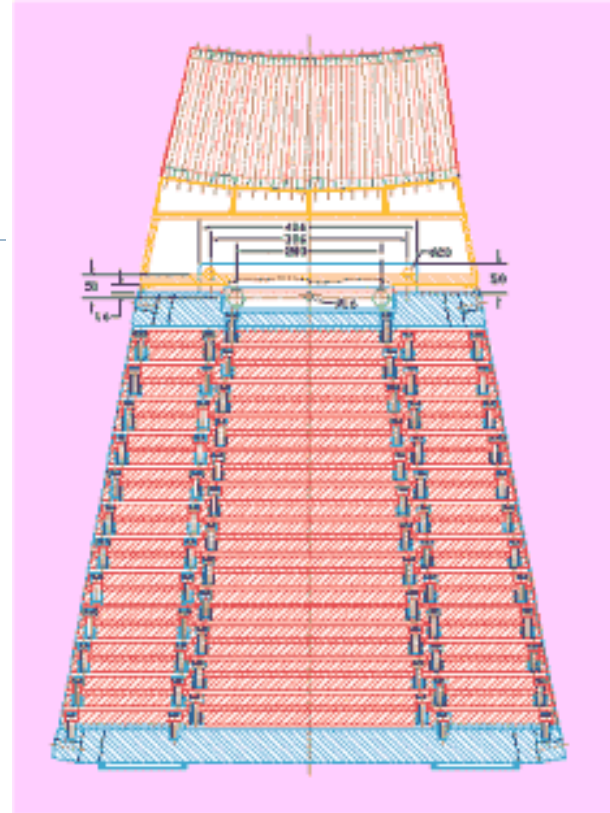

CMS HCAL

- ▶ > 5.8 (90 degrees) interaction lengths of material in the calorimeter
- ▶ The HCAL is inside the CMS solenoid (CMS is Compact)
- ▶ Tail catcher outside the CMS coil (an extra 4 interaction lengths)

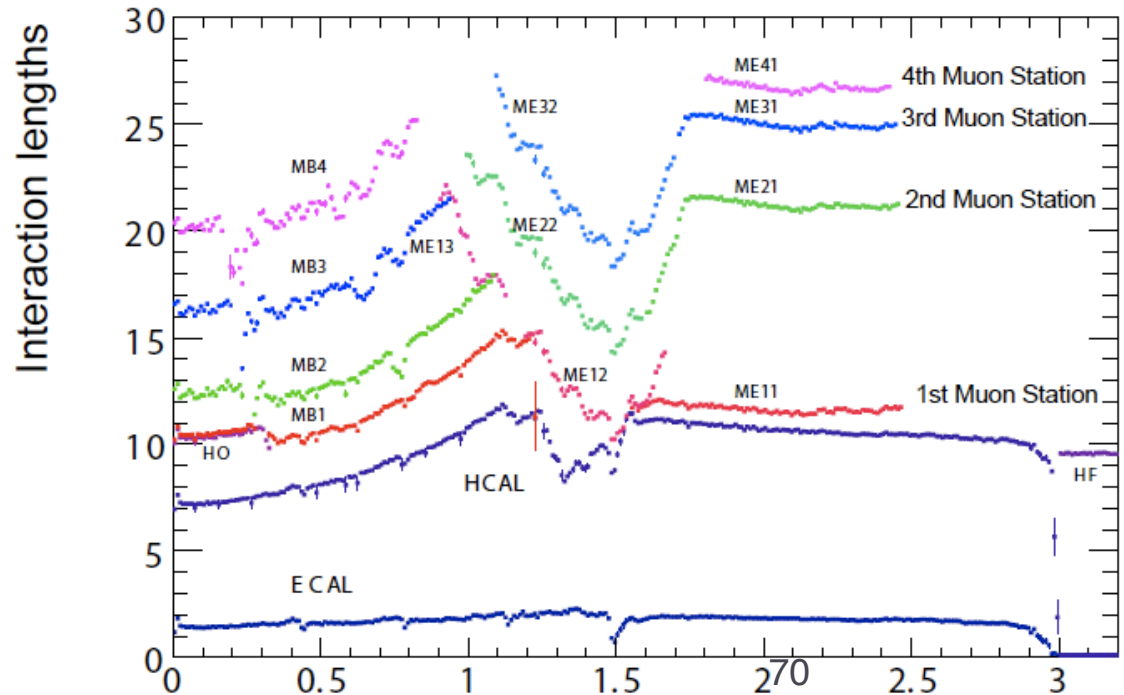
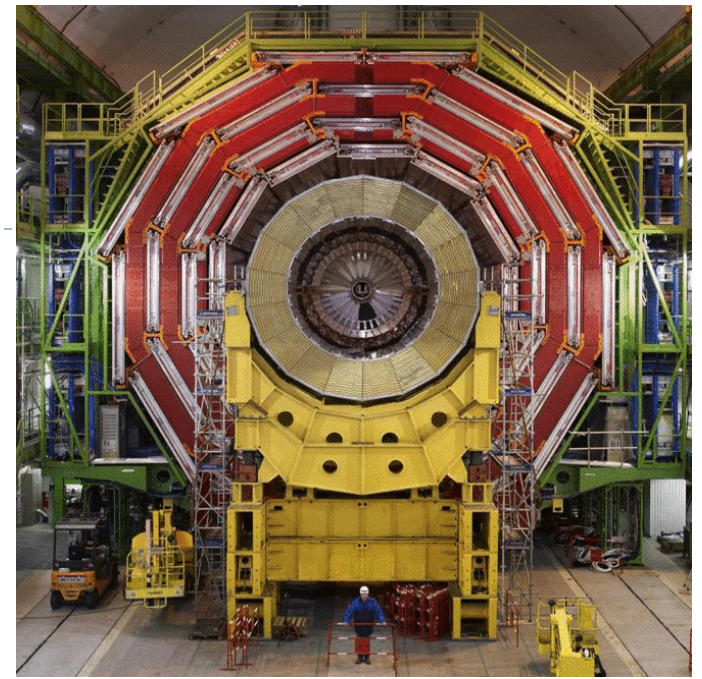

HCAL Readout

- ▶ Readout is provided by HPDs which consist of a fibre-optic entrance window onto which a multialkali photocathode is deposited, followed by a gap of several millimeters over which a large applied electric field accelerates photoelectrons onto a silicon diode target. The target is subdivided into individual readout elements called pixels. For CMS, 19-channel HPDs are used.
- ▶ The gain of HPDs is typically 2000-3000 for applied voltages of 10-15 kV. HPDs are capable of operating in high axial magnetic fields and provide a linear response over a large dynamic range.
- ▶ HPD has much smaller gain than a PMT implies electronics needs
 - ▶ High sensitivity/low noise
 - ▶ Large Bandwidth for BCID

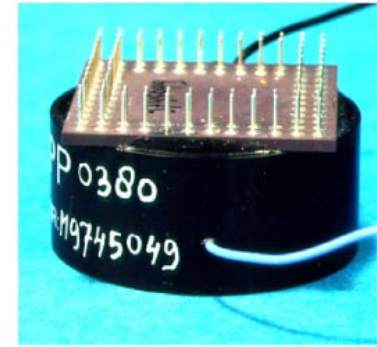
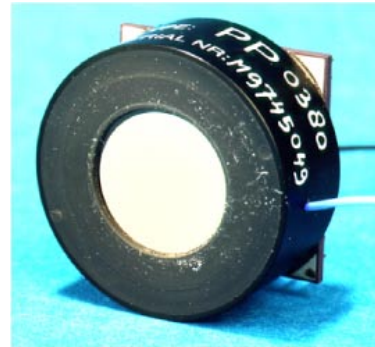
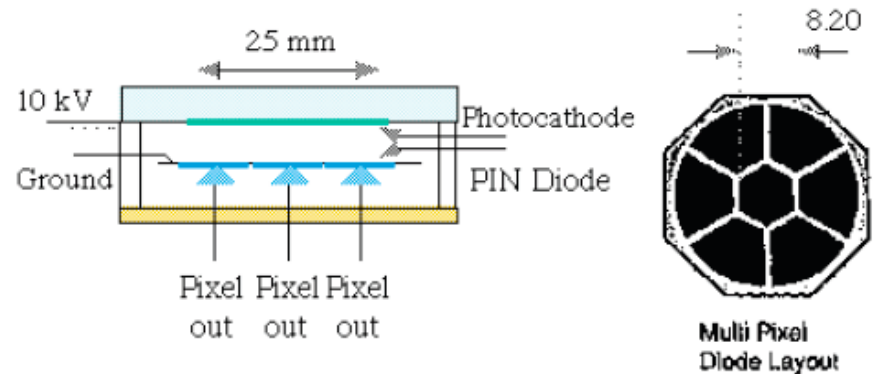

Energy in
EM Cal

Energy in
Had Cal

EM +
Had+ Tail



Signal Shape

5GeV/c pi-

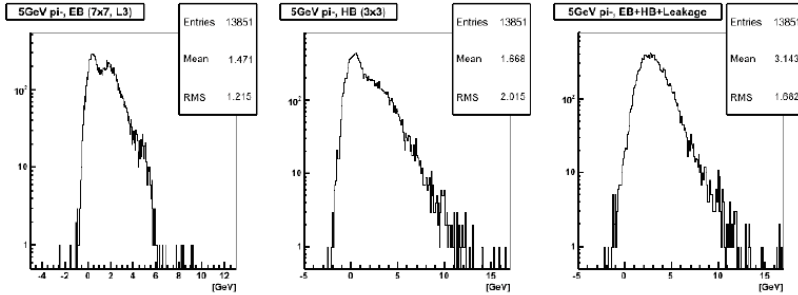

100 GeV/c pi-

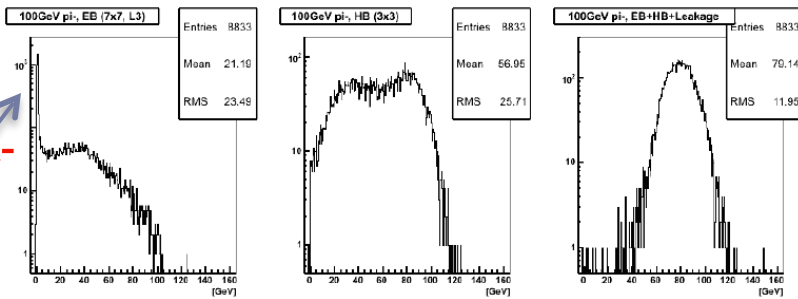

EB (7x7 xtals)

HB (3x3 towers)

EB + HB + Leakage

Note Peak at
minimum Ionizing
deposit in ECAL

Response Functions of Calorimeters

Turning the measured signals from Hadronic and Electromagnetic calorimeters into energy measurements for Jets requires a lot of detailed calibration

Testbeam measurements as well as detailed simulations are essential in understand had to turn the raw signals in the calorimeters into quantities which can be used for physics like Jet Energies and Missing Transverse Energy

Outline

- ▶ What are the requirements for Detectors in HEP?
 - ▶ The physics requirements
 - ▶ Coping with the environment
- ▶ Particles passing through matter
- ▶ Tracking Detectors
- ▶ Calorimetry
- ▶ **Muon Detection**
- ▶ Detectors for triggering/timing/particle ID
- ▶ Preparing for the future - higher luminosity implications

Muon Tracking

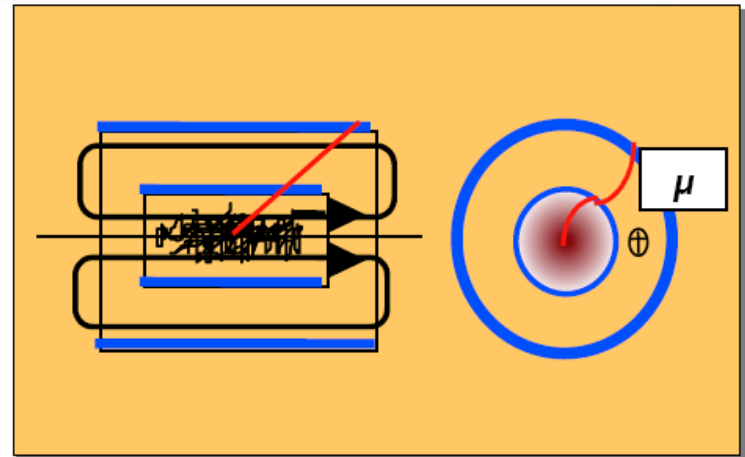
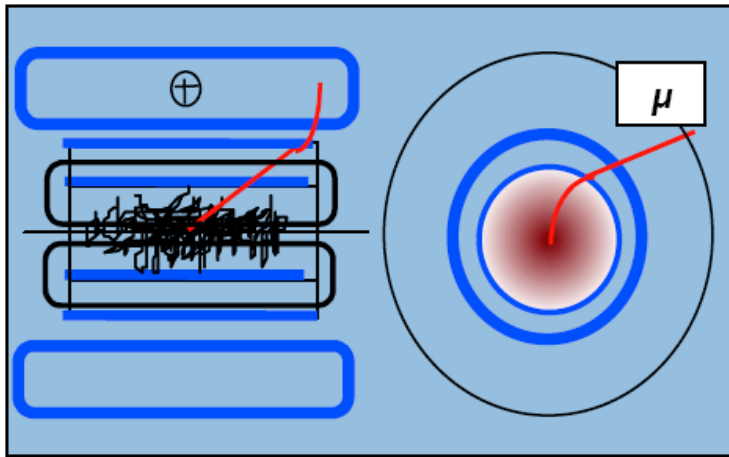
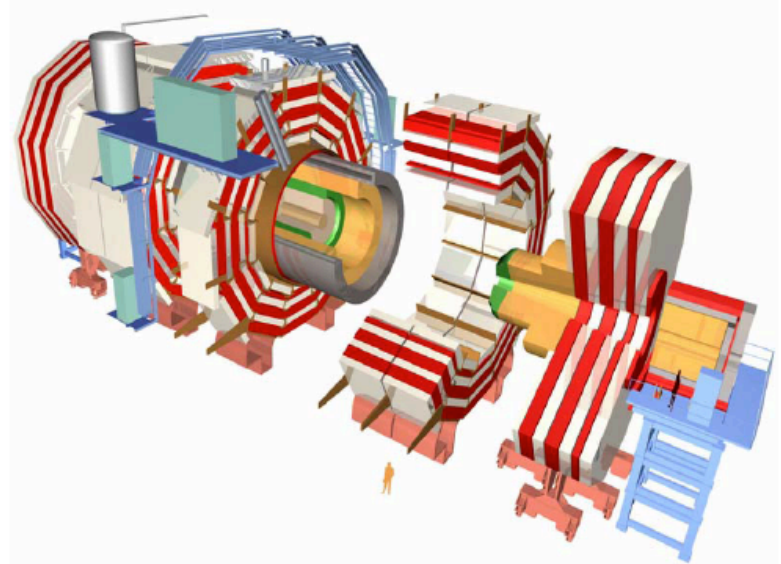
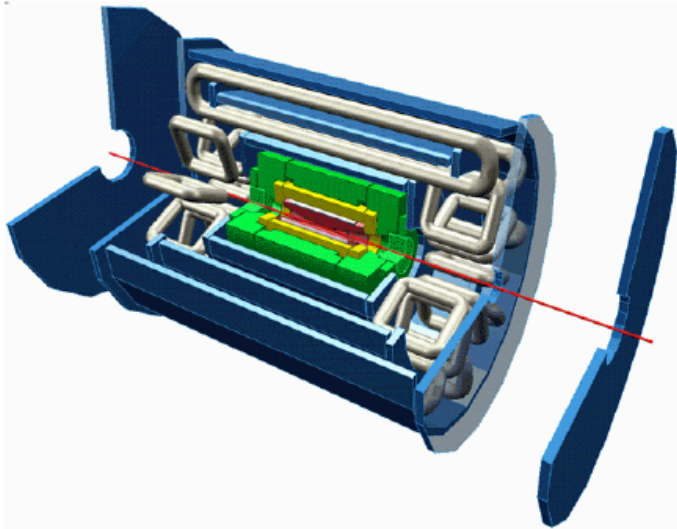

Finding Muons

- ▶ The flux return of the CMS coil returns through the steel of the yoke.
 - ▶ Notice the opposite sign of bending in the muon system
 - ▶ This allows CMS to be compact
- ▶ This is instrumented with muon chambers to track (and trigger) the muons which easily pass through the iron

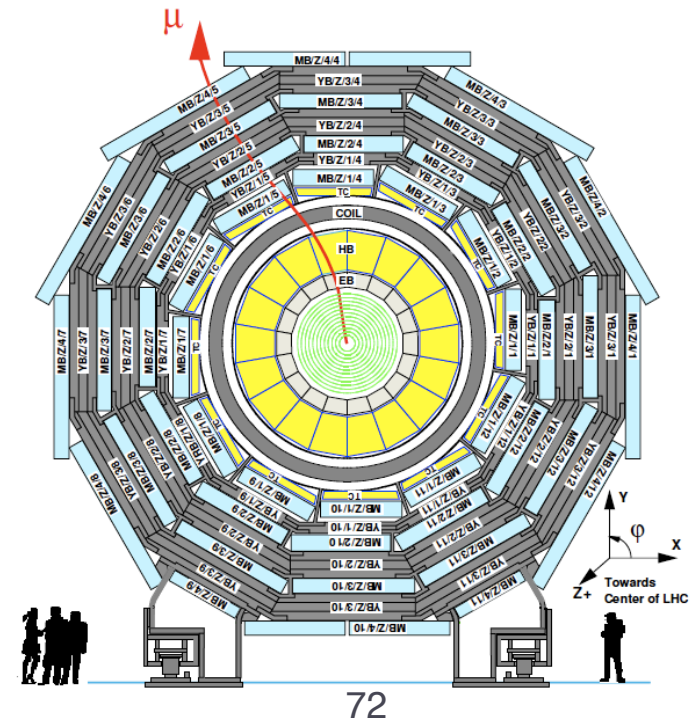
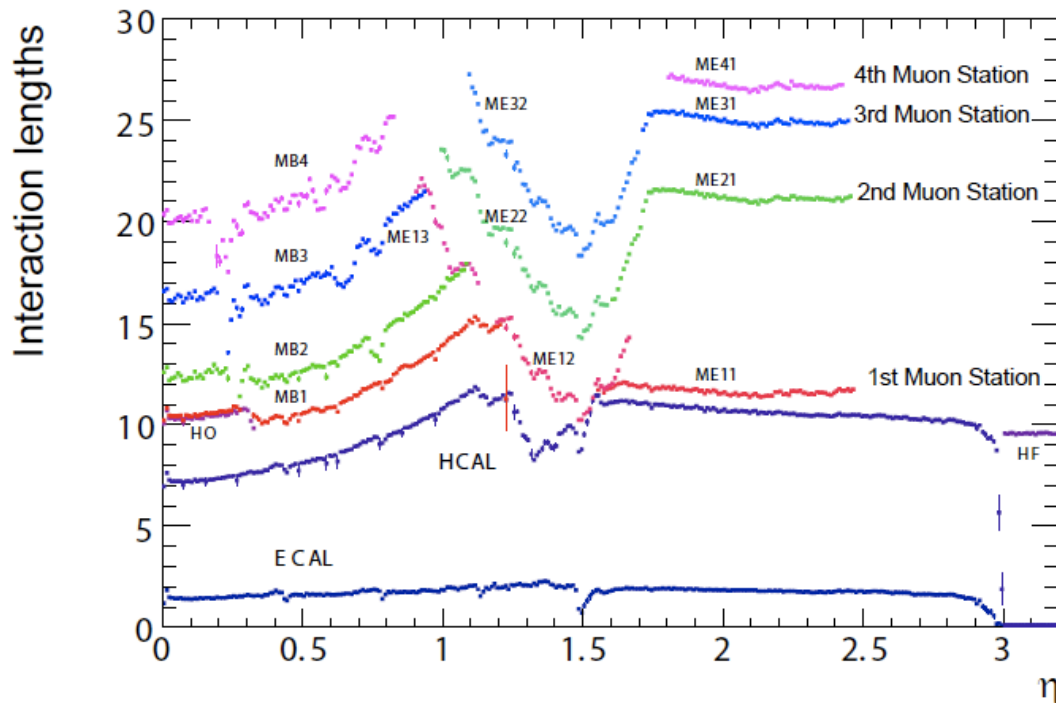

Atlas Muon detection

- ▶ The low material allowed by the ATLAS toroid magnet allows for precision tracking of muons
 - ▶ Lower multiple scattering
- ▶ Precision tracking chambers covering a very large surface area
 - ▶ Need something which is easy to mass produce

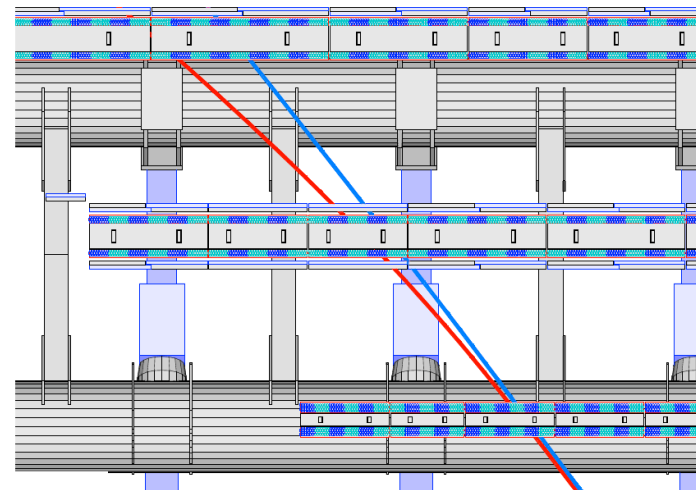
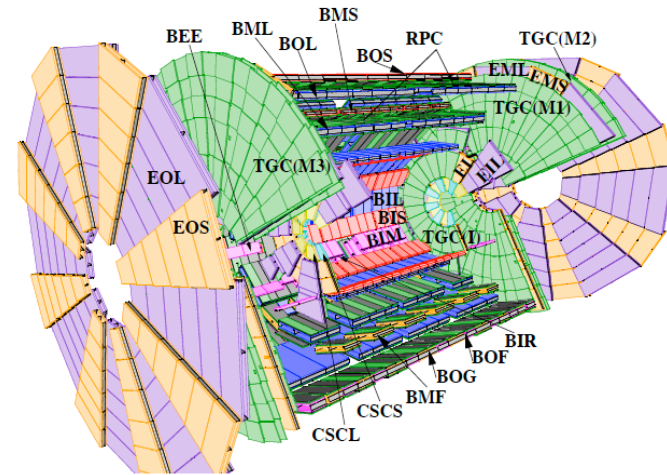

20 GeV and 4 GeV muons

ATLAS/CMS Muon System Resolutions

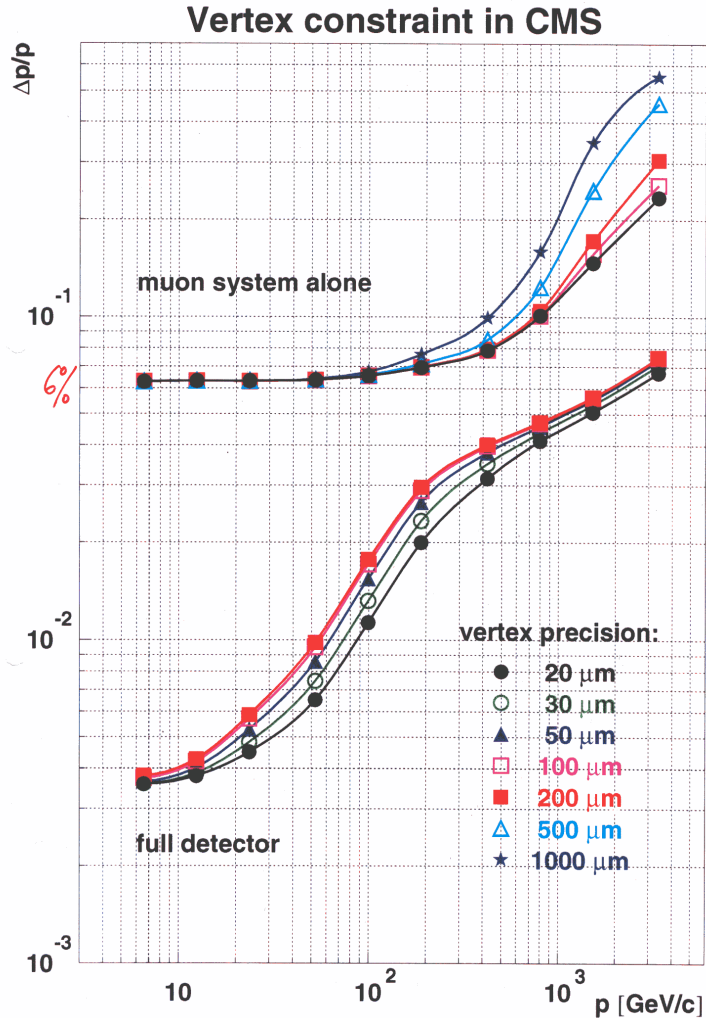

ATLAS Muon Spectrometer

μ momentum resolution

Contributions:

- Toroidal configuration \Rightarrow resolution \sim flat in η

Resolution (%)

$p_T = 100$ GeV
Standard sector

η

- Precision chamber accuracy (intrinsic resolution, alignment)
- Multiple scattering in magnet & chamber structures
- Energy loss fluctuations
- Momentum tails from pattern recognition errors

Contribution to resolution (%)

$\eta < 1.5$

- ▼ Tube resolution = auto calibration (dashed)
- Chamber alignment
- Multiple scattering
- Energy loss fluctuations
- △ Total

p_T (GeV)

- Inner tracker measurement

W. Kozanecki

LHCC Open Presentation, 5 June 1997

General considerations for Muon tracking detectors

- ▶ Muon tracking detectors need to cover a very large surface area
- ▶ Need a technology which is relatively inexpensive to produce on a large scale
- ▶ The occupancy should be much lower in the outer parts of the detectors, so can relax some of the requirements on granularity
 - ▶ Detectors with lower rate capability and less position resolution can be considered
 - ▶ We still want reasonable position resolution to allow us to determine the muon momentum precisely
- ▶ These chambers are often also used to form an input to the trigger system
 - ▶ High momentum muons are a very important signal of some interesting physics which we would like to trigger on

Multi Wire Proportional Counters

- ▶ String together several wires in parallel
 - ▶ 2mm separation
- ▶ Place between two cathode planes
- ▶ Charged tracks ionisation causes avalanche
 - ▶ Determine which wire the track passed closest to
- ▶ More information
 - ▶ stack perpendicular plane on top to get second coordinate
 - ▶ read charge on both ends of the wire
 - ▶ segment the cathode into strips and measure the induced charge on the cathode strips
- ▶ This configuration of wires can be unstable

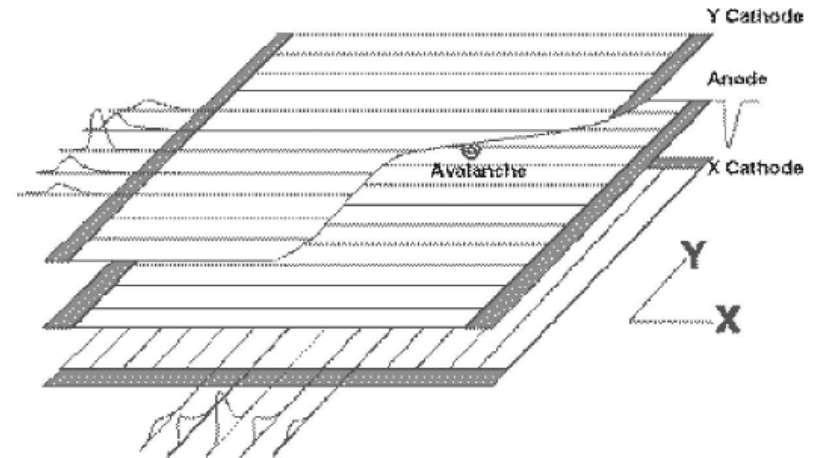
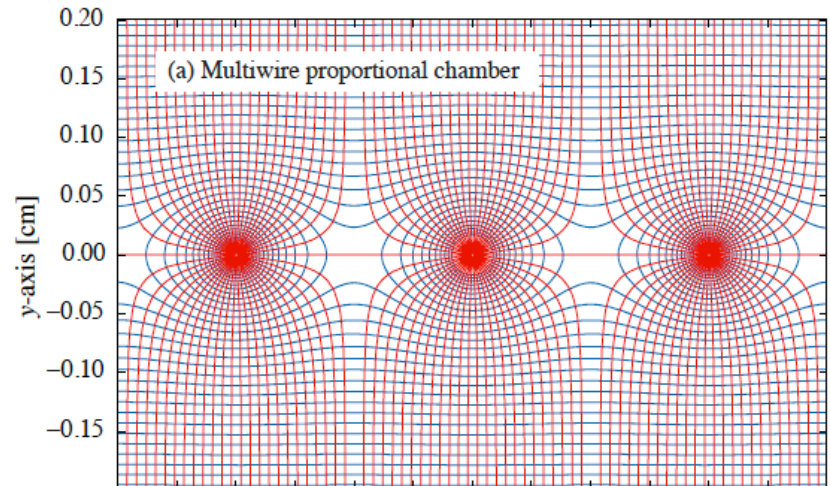

Drift Chambers/Drift Cells

- ▶ Insert extra wires at intermediate fields to help shape the field lines
- ▶ Wires can be further apart
- ▶ Drift of electrons can be made very uniform
 - ▶ Time to distance relationship allows for precise location of passage of charged track

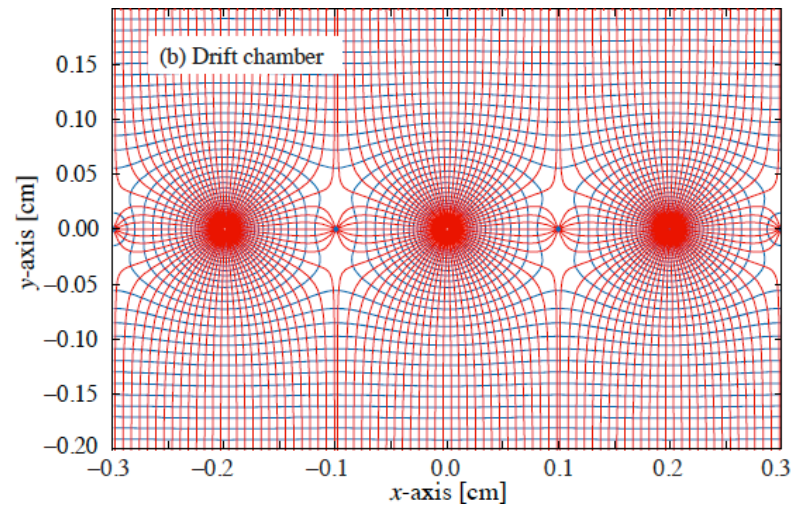
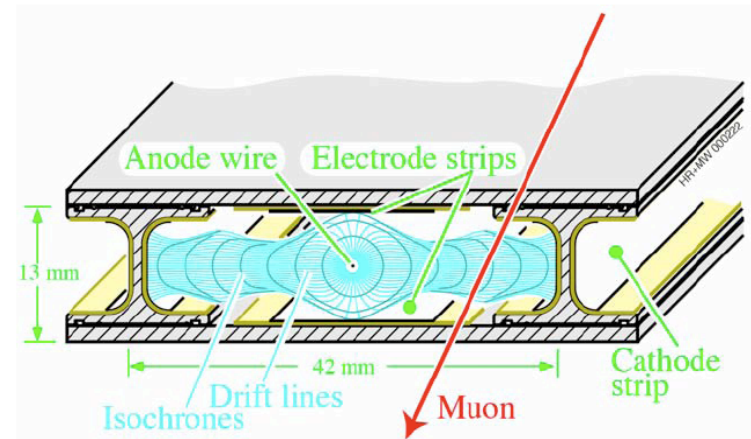

CMS Drift Tubes

High Voltage

Cathode Strips

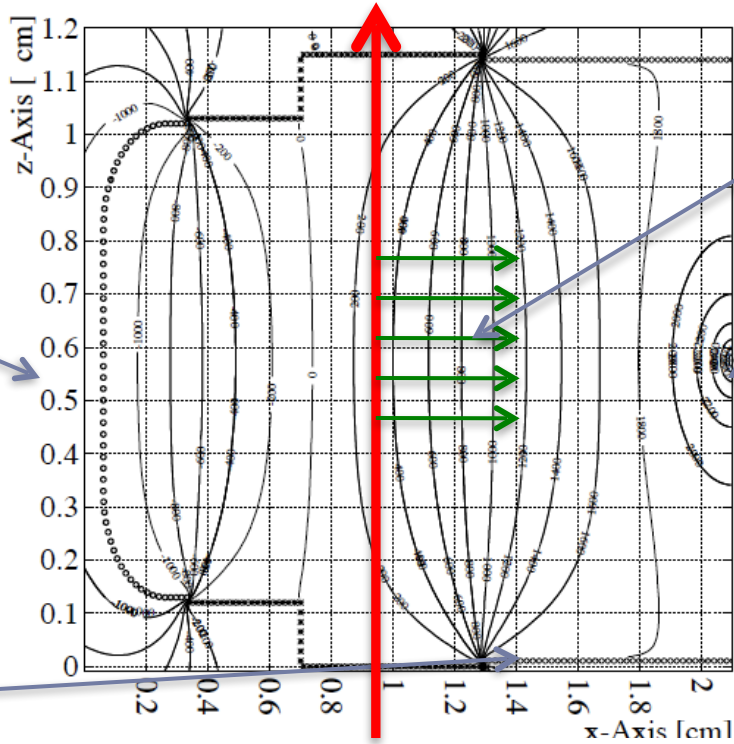

Ionization electrons drifting to anode

Anode Wire

- ▶ Drift Cells 4cm x 1cm
- ▶ Cathode strips on the cell walls to shape the field
- ▶ Uniform and fairly rapid drift to the wire
 - ▶ Drift velocity around $50\mu\text{m}/\text{ns}$
- ▶ Can measure position in cell from the drift time

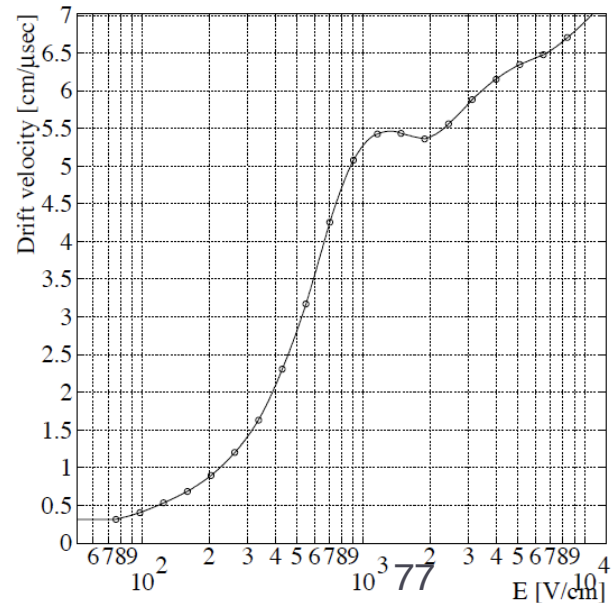

CMS Muon Drift Tubes

- ▶ Cells are mass produced and stacked in 3 stacks of 4 chambers
- ▶ About 2mx2m
- ▶ one stack of chambers orthogonal to the other two

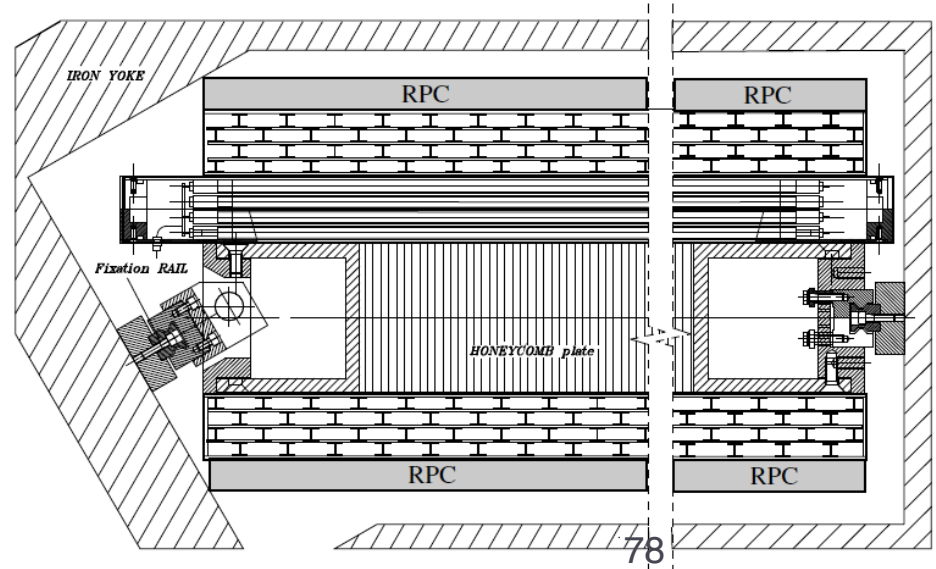
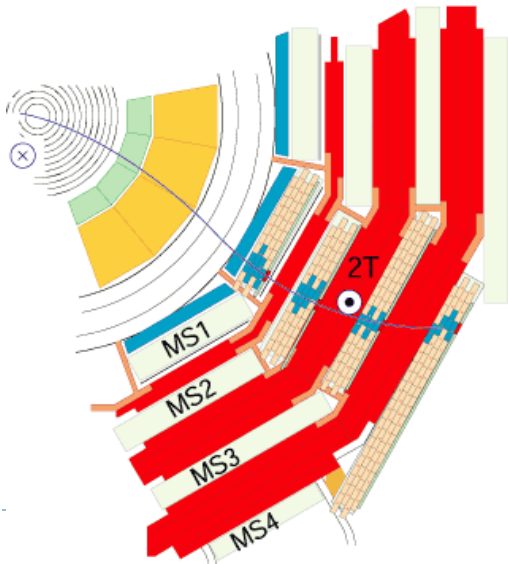
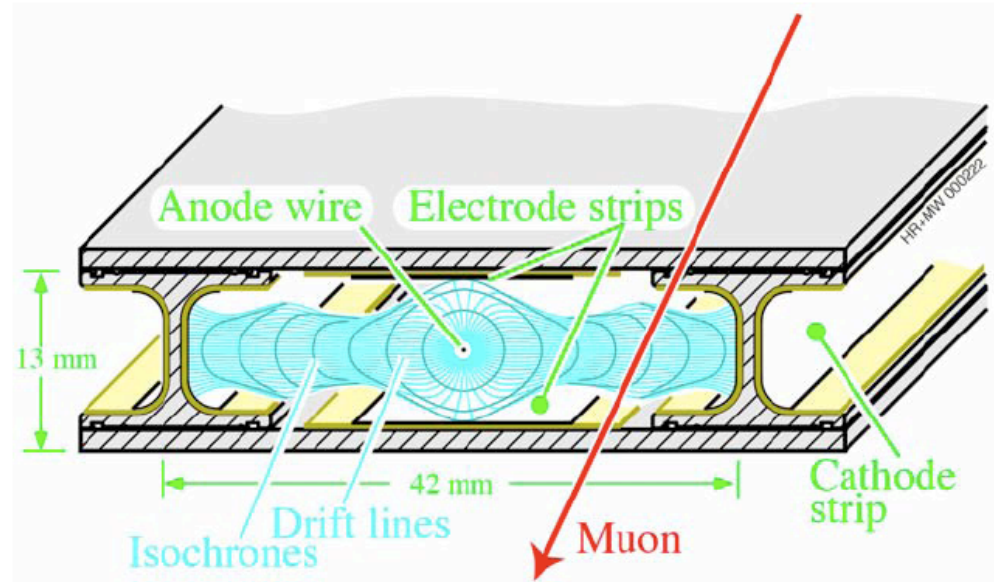

ATLAS Monitored Drift Tube

- ▶ Drift Tubes 3cm in Diameter
- ▶ Gas gain 10^4
- ▶ Long drift time (up to 25 Beam crossings)
 - ▶ Limits rate to about
 - ▶ 150 Hz/cm²
- ▶ Position resolution about 80 μm

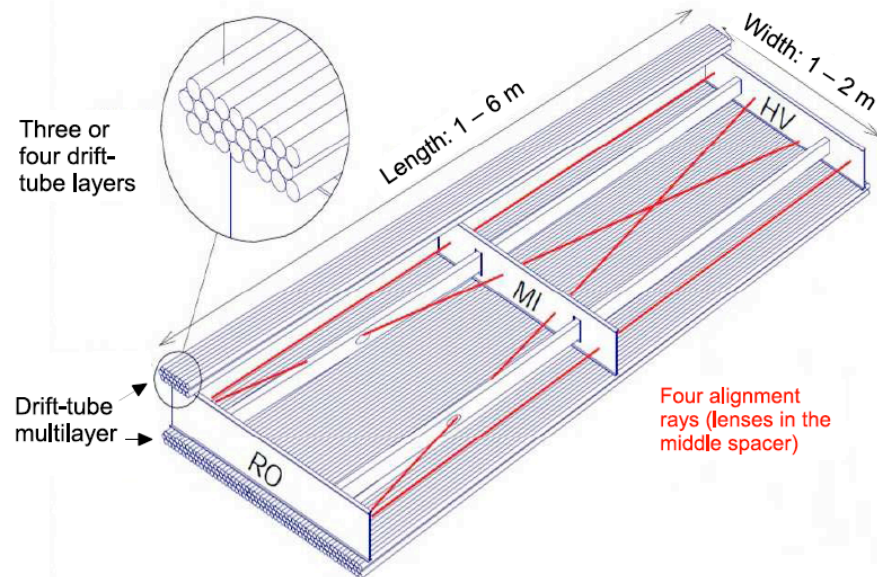
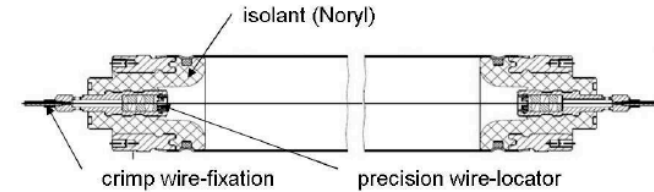
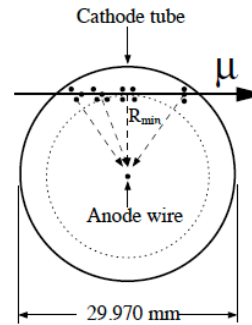

| Parameter | Design value |
|-----------------------------|--------------------------------------------------------------|
| Tube material | Al |
| Outer tube diameter | 29.970 mm |
| Tube wall thickness | 0.4 mm |
| Wire material | gold-plated W/Re (97/3) |
| Wire diameter | 50 μm |
| Gas mixture | Ar/CO ₂ /H ₂ O (93/7/ ≤ 1000 ppm) |
| Gas pressure | 3 bar (absolute) |
| Gas gain | 2×10^4 |
| Wire potential | 3080 V |
| Maximum drift time | ~ 700 ns |
| Average resolution per tube | ~ 80 μm |

Muon Cathode Strip Chambers (CSC)

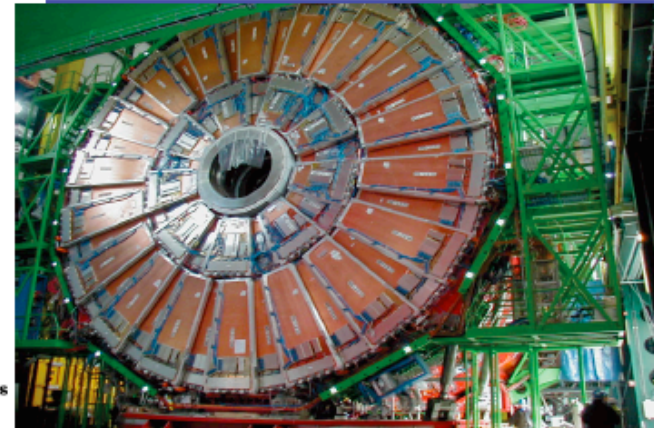
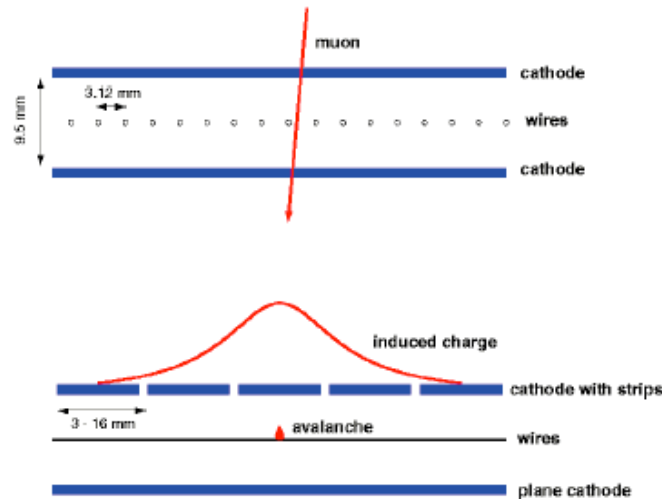
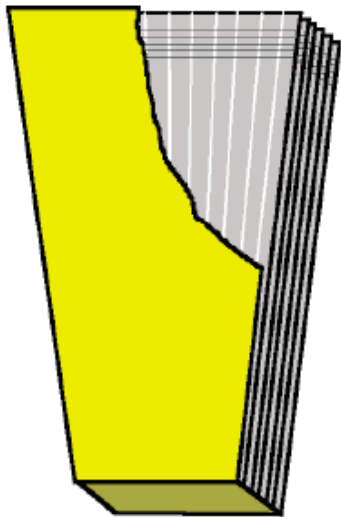

- Anode Wires in Azimuth
 - Bending is in Azimuthal direction
 - Give Precise timing
- Cathode Strips radial
 - Give Precise positioning from knowledge of charge in strips
- 6 Layers used for fast track finding
 - 160,000 channels

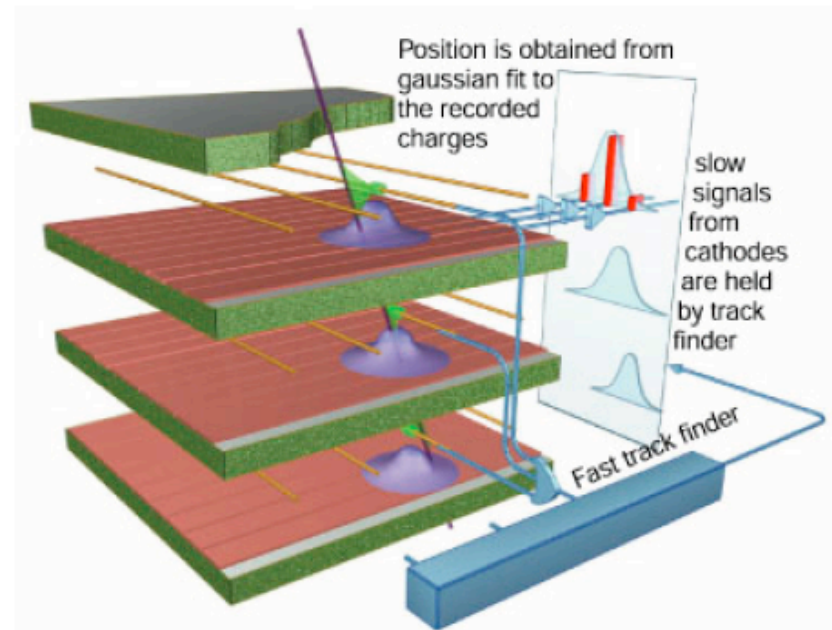

CMS Cathode Strip Chambers

- ▶ Cathode strip chambers (CSC) are used in the endcap disks
 - ▶ magnetic field is uneven
 - ▶ particle rates are high
- ▶ Positive ions move away from the wire and towards the copper cathode, also inducing a charge pulse in the strips, at right angles to the wire direction.
 - ▶ the strips and the wires are perpendicular giving two position coordinates for each passing particle.
 - ▶ the closely spaced wires make the CSCs fast detectors suitable for triggering.
- ▶ Each CSC module contains six layers making it able to accurately identify muons and match their tracks to those in the tracker
- ▶ Innermost layer is inside the CMS solenoid
 - ▶ In these chambers, the wires are tilted to correct for the lorentz angle drift of the ionization

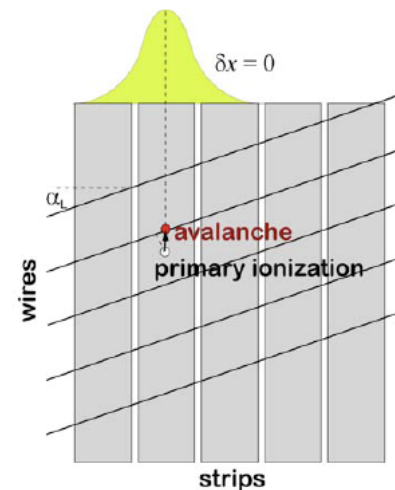
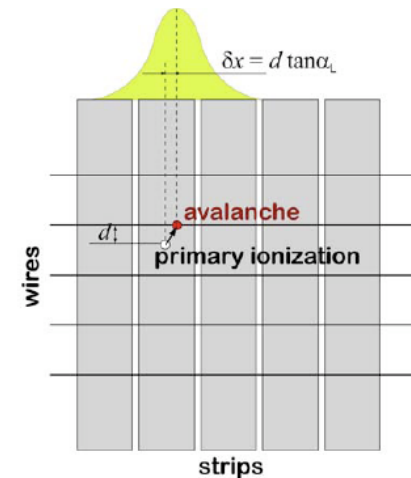

ATLAS CSC

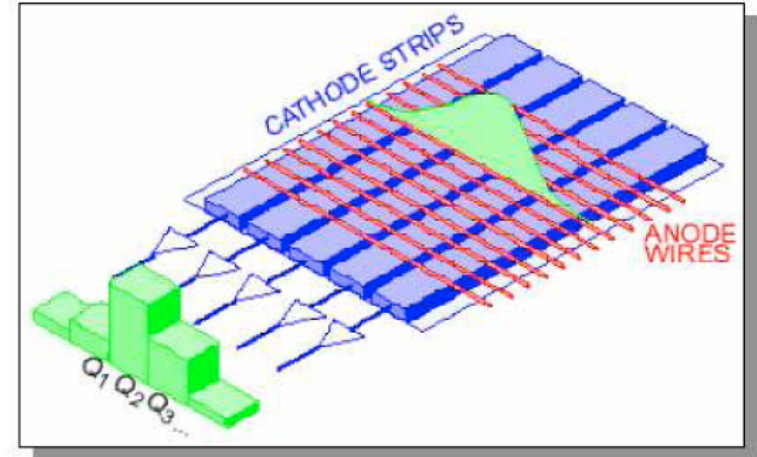
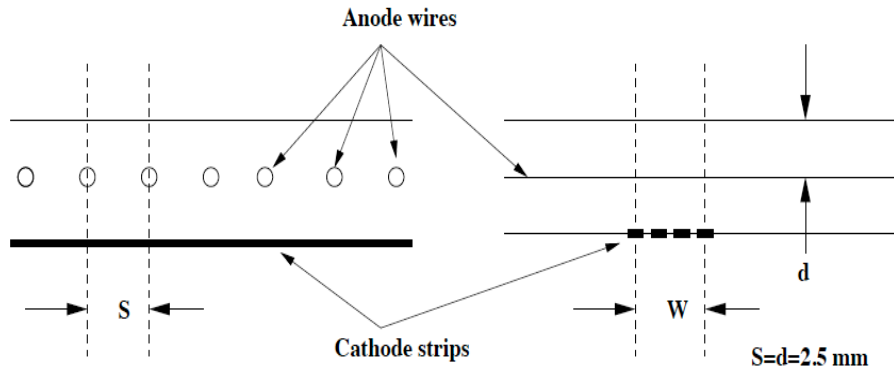

- ▶ Endcap region of ATLAS
- ▶ Need high rate capability
 - ▶ Up to 1000 Hz/cm²
- ▶ Segmented cathode strips have a charge induced on them by the avalanche on the anode wires
- ▶ Strips read for both coordinates
 - ▶ Wires are radial (not read out)
- ▶ Strips about 1.5 mm wide separated by .25 mm

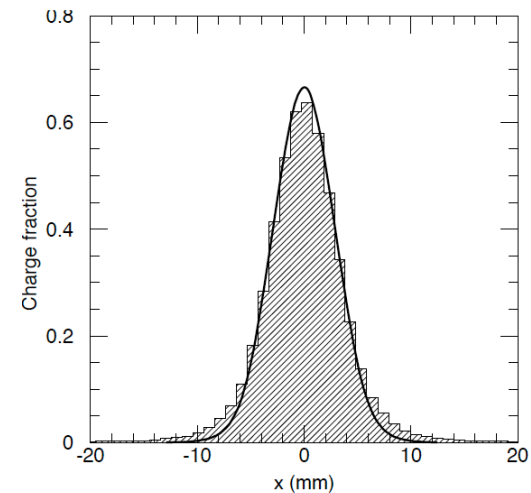
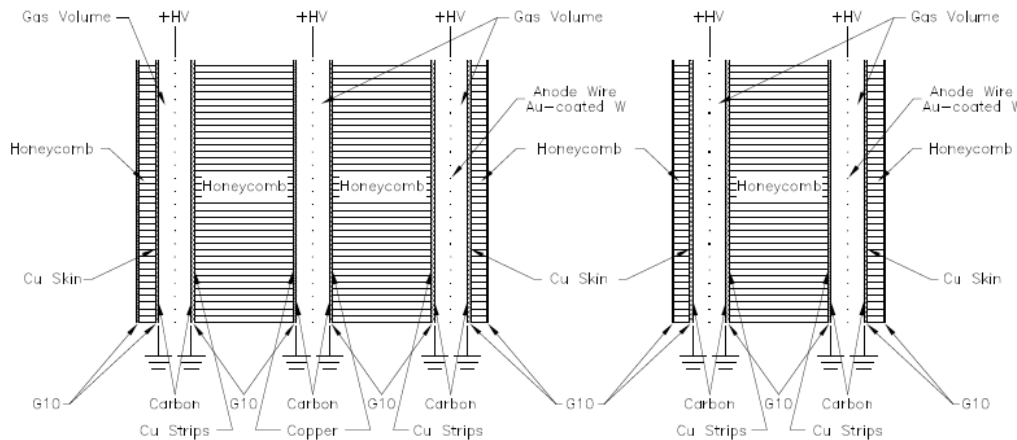
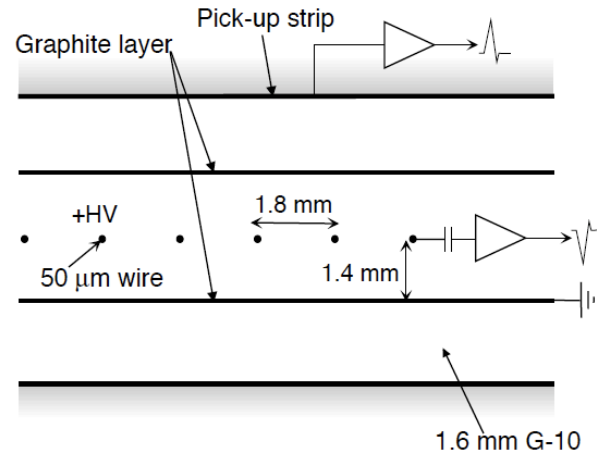

Figure 6.15: Charge distribution on the CSC cathode induced by the avalanche on the wire.

ATLAS TGC (Thin Gap Chamber)

- ▶ MWPC
- ▶ Provide input to the Trigger
 - ▶ Signals arrive within 25 ns
- ▶ Measure Azimuthal coordinate to complement MDTs
 - ▶ Radial Strips are read out
- ▶ Wires measure in bending plane
- ▶ Very good time resolution



| Parameter | Design value |
|-------------------|------------------------------------|
| Gas gap | 2.8 ± 0.10 mm |
| Wire pitch | 1.8 ± 0.05 mm |
| Wire diameter | 50 μ m |
| Wire potential | 2900 ± 100 V |
| Operating plateau | 200 V |
| Gas mixture | CO ₂ /n-pentane (55/45) |
| Gas amplification | 3×10^5 |

ATLAS Muon system summary

| Type | Function | Chamber resolution (RMS) in | | | Measurements/track | | Number of | |
|------|----------|-----------------------------|--------|--------|--------------------|---------|-------------|-------------|
| | | z/R | ϕ | time | barrel | end-cap | chambers | channels |
| MDT | tracking | 35 μm (z) | — | — | 20 | 20 | 1088 (1150) | 339k (354k) |
| CSC | tracking | 40 μm (R) | 5 mm | 7 ns | — | 4 | 32 | 30.7k |
| RPC | trigger | 10 mm (z) | 10 mm | 1.5 ns | 6 | — | 544 (606) | 359k (373k) |
| TGC | trigger | 2–6 mm (R) | 3–7 mm | 4 ns | — | 9 | 3588 | 318k |

- ▶ ATLAS uses four types of technologies to track and trigger on Muons
- ▶ This system covers a huge surface area
- ▶ More than a million channels of readout required

Outline

- ▶ What are the requirements for Detectors in HEP?
 - ▶ The physics requirements
 - ▶ Coping with the environment
- ▶ Particles passing through matter
- ▶ Tracking Detectors
- ▶ Calorimetry
- ▶ Muon Detection
- ▶ **Detectors for triggering/timing/particle ID**
- ▶ Preparing for the future - higher luminosity implications

Building *Trigger Primitives*

- ▶ The trigger systems work with inputs from the detector which give a very fast signal that there is something worth looking at in the detector
- ▶ The instrumentation for this must very quickly
 - ▶ Gather the signal from the detector (can't have very long drift times for instance)
 - ▶ Put together the signals from several detector elements to look for interesting patterns
 - ▶ For example high momentum muon tracks
 - ▶ Large deposits of energy in the calorimeters in a small region
 - ▶ Send this information to the trigger system for further processing

RPCs

- ▶ Resistive plate chambers (RPC) fast gaseous detectors
 - ▶ Relatively inexpensive to cover a large area
- ▶ RPCs consist of two parallel plates
 - ▶ a positively-charged anode and a negatively-charged cathode,
- ▶ Plates are made of a very high resistivity plastic material and separated by a gas volume.
- ▶ Ionizing muons cause an avalanche of electrons
 - ▶ very high field means avalanche starts immediately
- ▶ The electrodes are transparent to the signal (the electrons), which are instead picked up by external metallic strips after a small but precise time delay.
- ▶ RPCs combine a good spatial resolution with a time resolution of just one nanosecond.

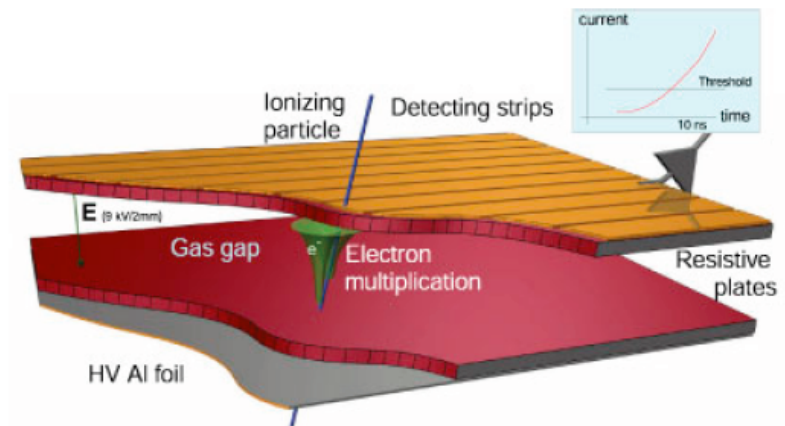
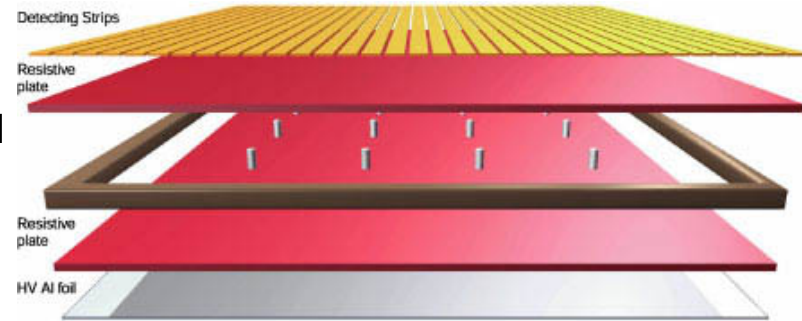
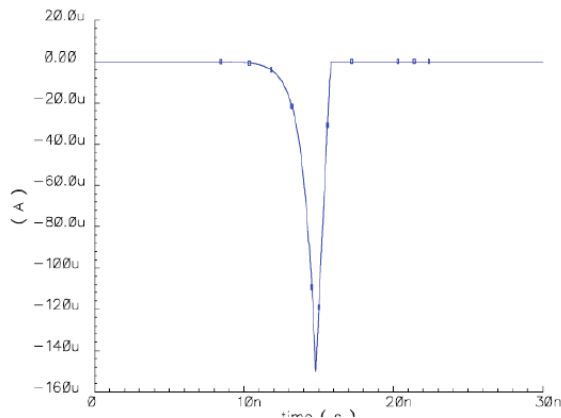

Muon Triggers Primitives

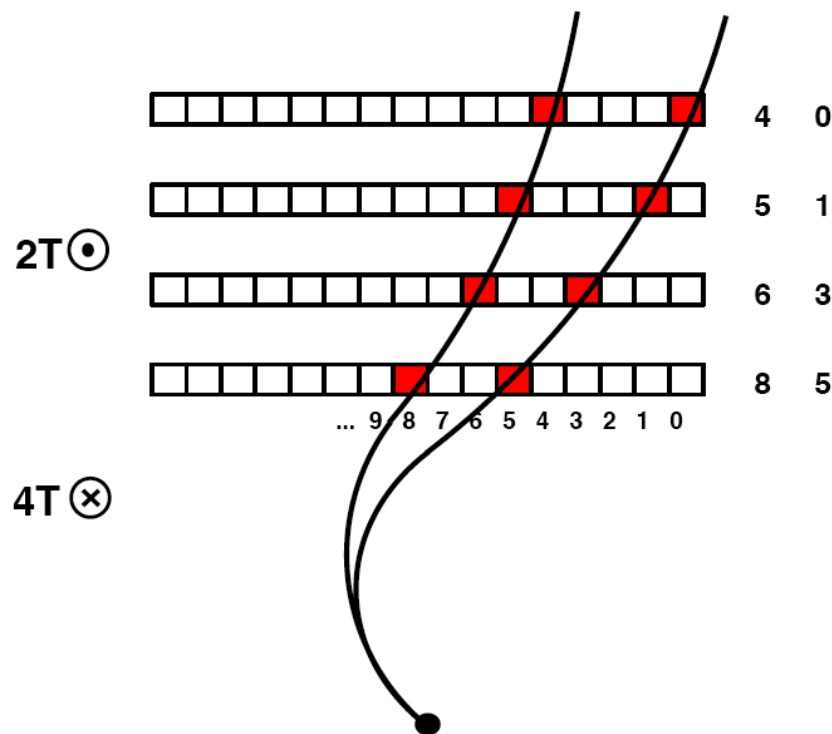
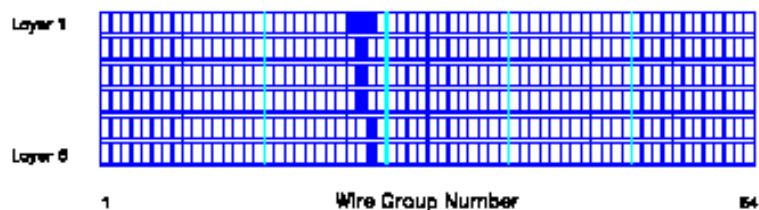
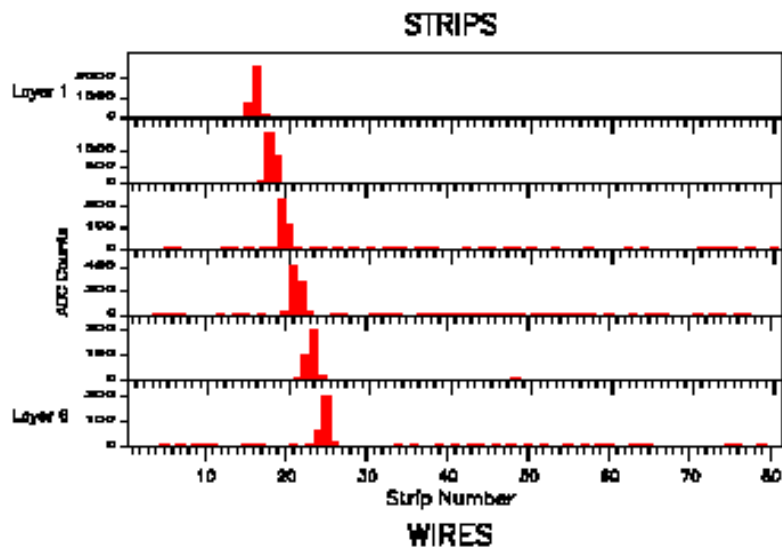

Pattern of hit strips is compared to predefined patterns corresponding to various p_T

DriftTubes Local-Trigger

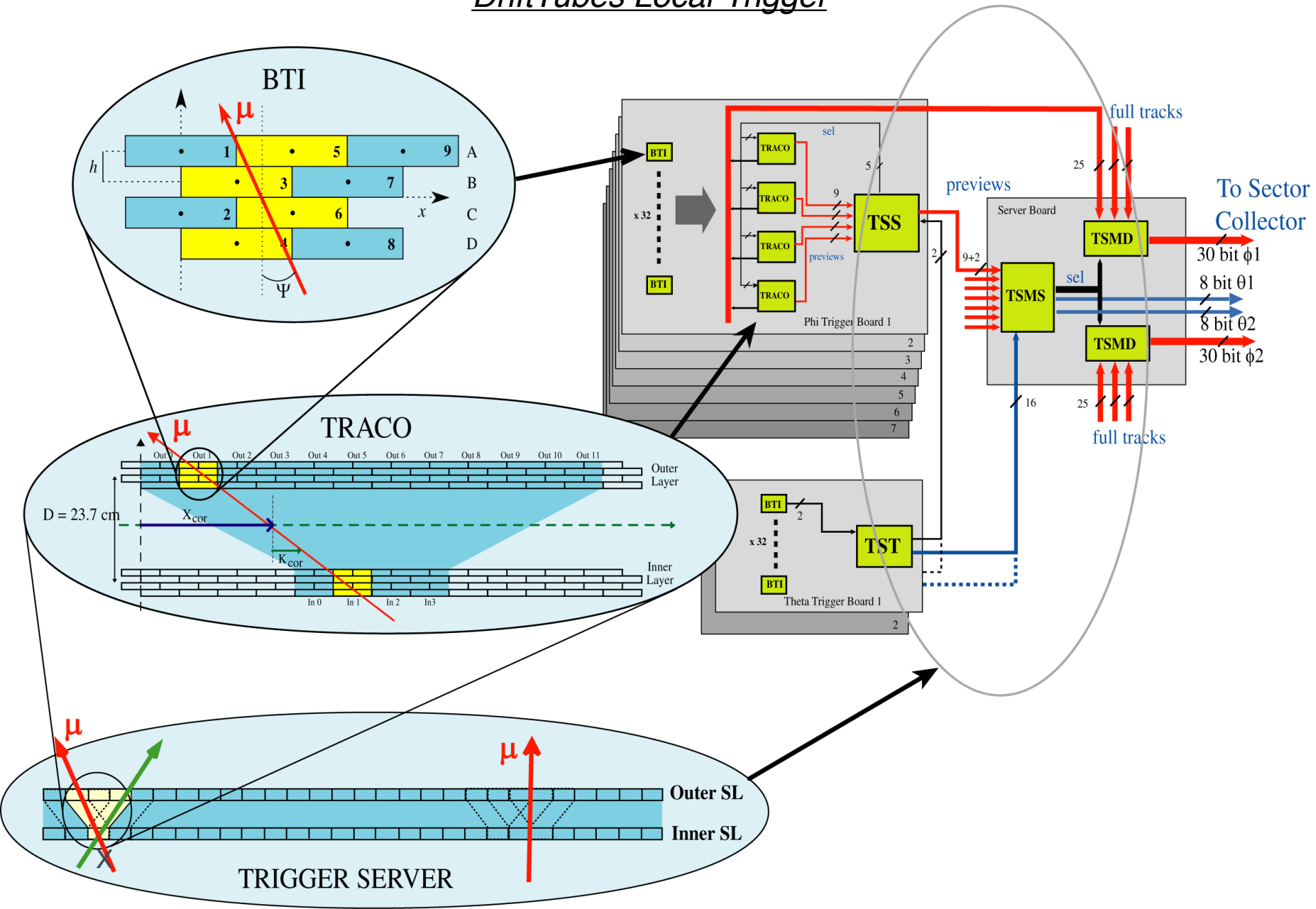

Calorimeter trigger objects

▶ Electrons

- ▶ Look at Sum E_t and H/E
 - ▶ Isolated
 - ▶ Non-Isolated

▶ Jets

- ▶ Looking for energy deposited in a cluster in the calorimeters
- ▶ Requires handling information from large areas of the calorimeter
- ▶ Large amount of data to collect/correlate at 40 MHz

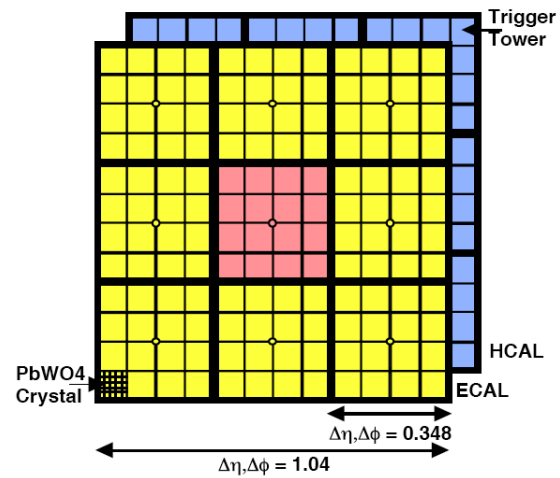
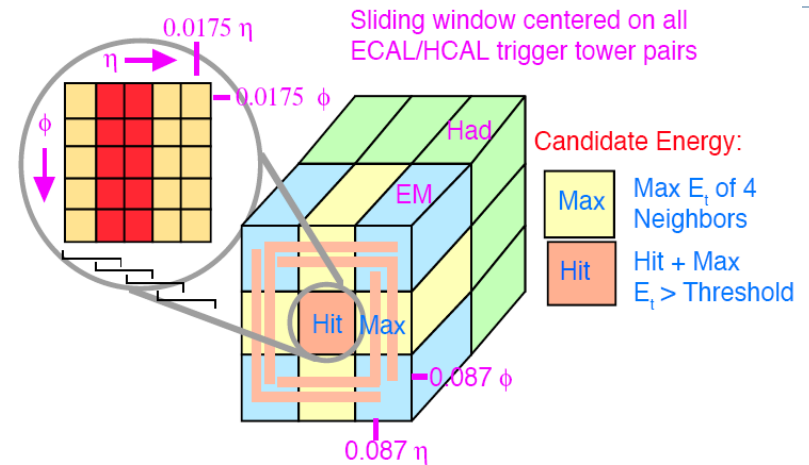

Particle ID

- ▶ We have seen how the detectors have good capability for identifying the electrons and muons
 - ▶ These are vital signatures of interesting physics and form the cornerstone of many of our triggers
- ▶ We can use other detectors to try and combine information about a particles momentum and velocity in order to discern its mass
 - ▶ One example, recall the dE/dx plot
 - ▶ Measuring the momentum and the deposited energy can allow us to identify different species of charged particle in limited momentum ranges
 - ▶ Requires making many measurements of dE/dx for a given track (recall Landau fluctuations)
- ▶ Particle ID can be quite important for some measurements
 - ▶ E.g. π/K separation in B-K π decays

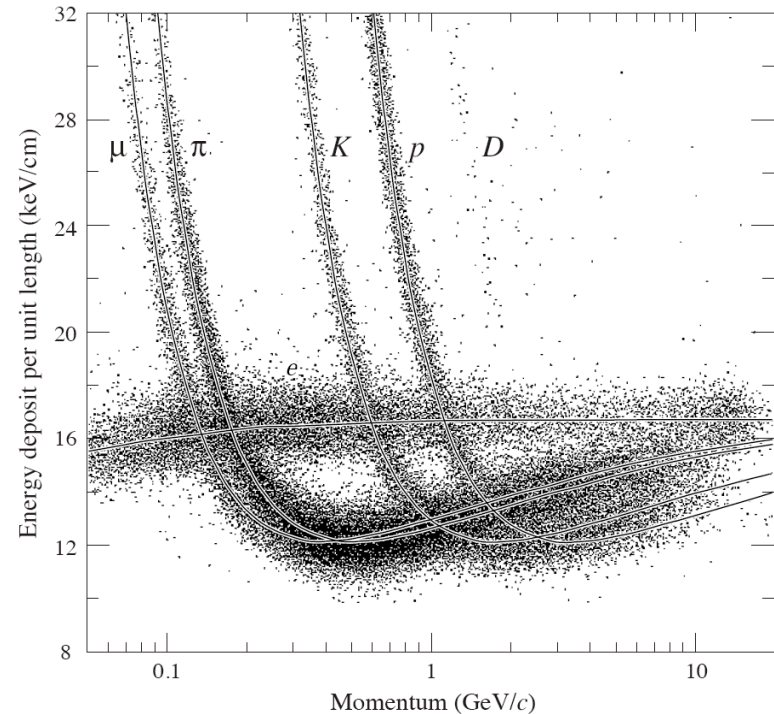

TRD

- ▶ When particle pass through a region with a discontinuous refractive index they can emit Transition Radiation
- ▶ These are only emitted for particles with a very high β (of order 1000, so really only seen for electrons)
- ▶ The photons from transition radiation have an energy of order 10KeV
- ▶ In the ATLAS TRT, these photons are absorbed by the gas, and give a larger signal than the minimum ionizing signal.
 - ▶ Straws are packed in radiator material
- ▶ In each straw, look for larger hits which signal a possible TR hit
- ▶ Can provide electron ID

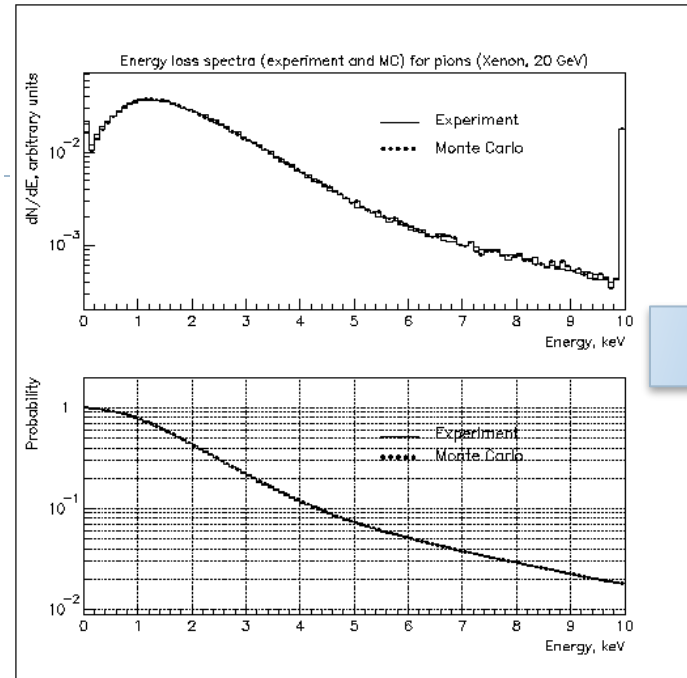

Pions

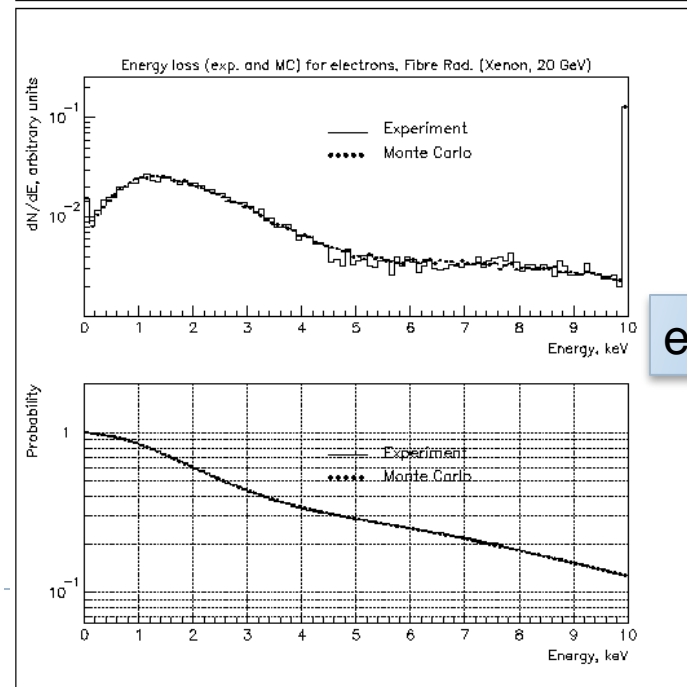

electrons

RICH Detectors

- ▶ If a particle enters a medium, and it has a velocity greater than the speed of light in that medium, it will emit Cerenkov photons at an angle dependent on its velocity
- ▶ These photons can be detected and used in combination with a measurement of the particles momentum in order to determine the mass of the particle
- ▶ LHCb has two Ring Imaging Cerenkov Detectors to help with particle ID
 - ▶ RICH 1 –
 - ▶ Low Momentum (1-60 GeV)
 - ▶ Aerogel and C_4F_{10}
 - ▶ RICH 2
 - ▶ High Momentum (15 – 100GeV)
 - ▶ CF_4 gas

$$\cos \theta = \frac{c/nt}{\beta ct} = \frac{1}{\beta n}$$

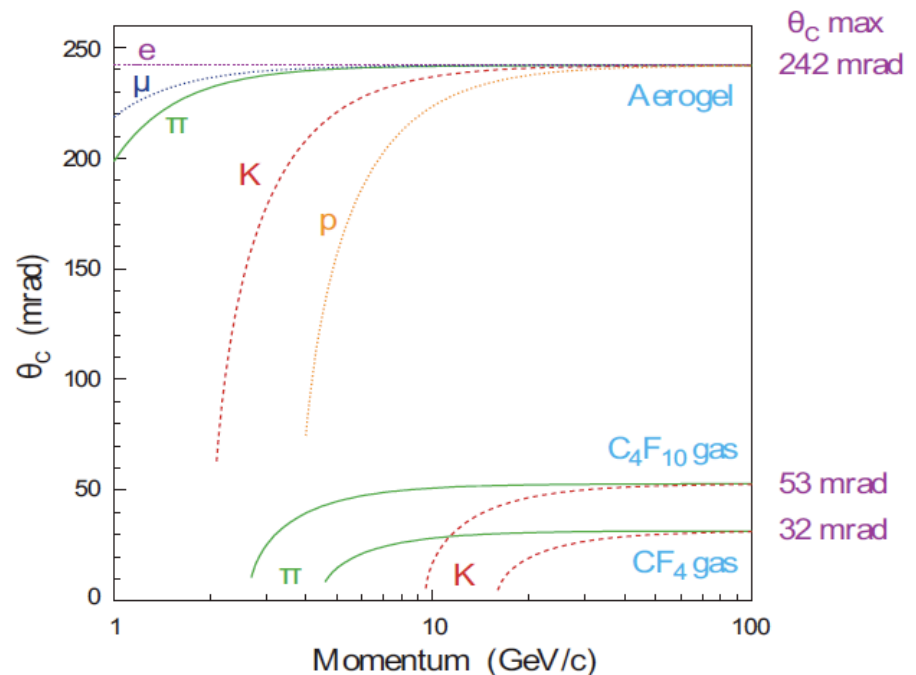

LHCb RICH 1

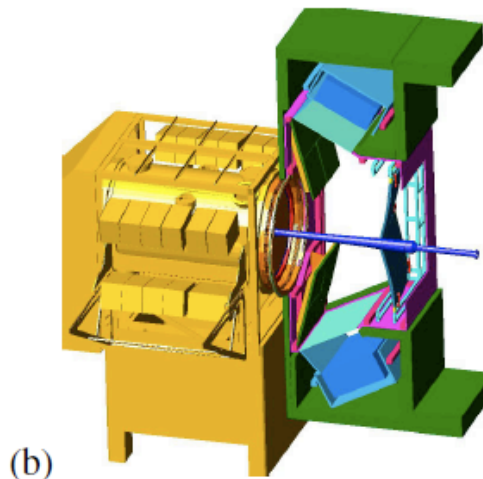
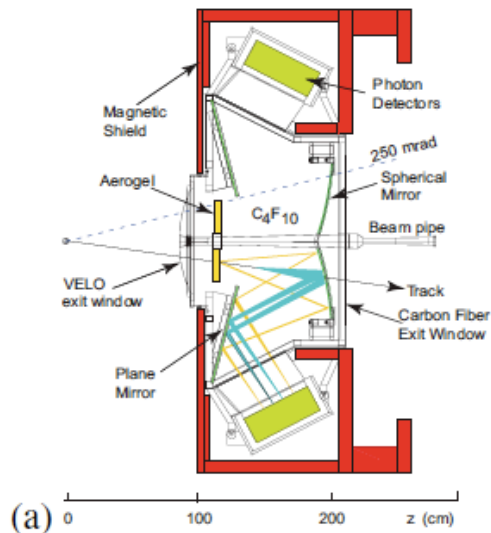

- ▶ Photons are emitted in a ring around the direction of the particle
- ▶ The photons are transported by mirrors to sensitive photon counters which can image the rings
- ▶ The radius of the ring combined with the particle momentum measurement gives a particle ID

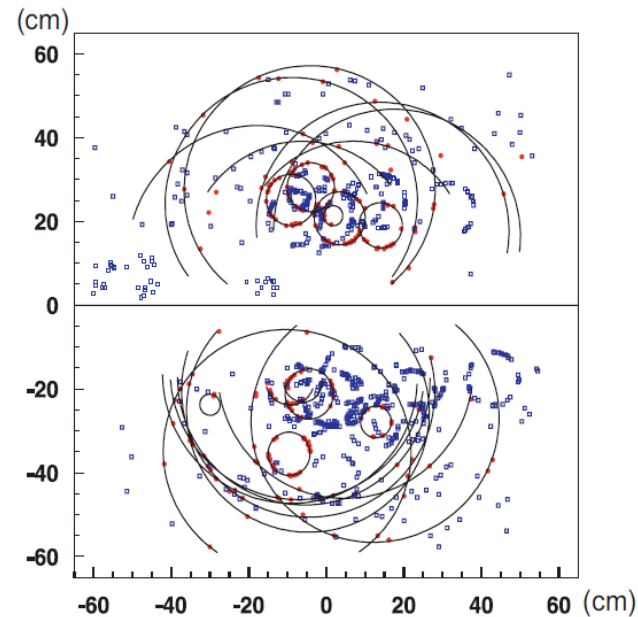

TOF

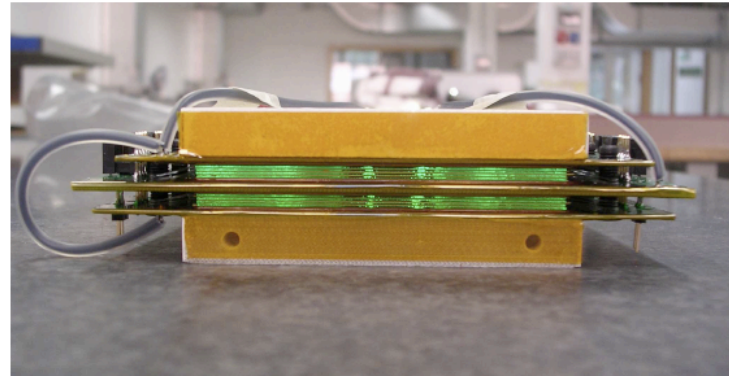
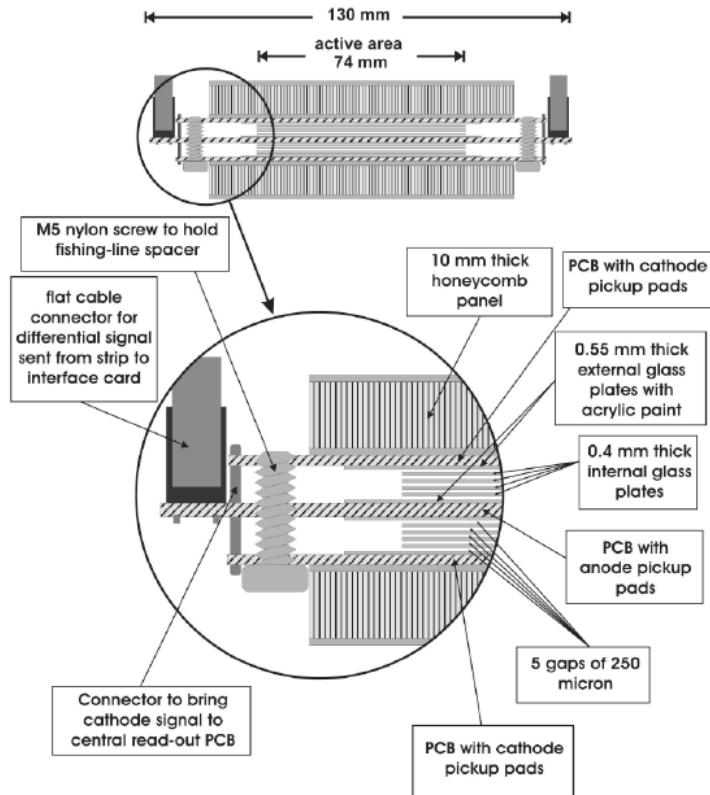

- ▶ Time Of Flight is another method of Particle Identification
- ▶ It works by measuring very accurately the arrival time at the detector of particles coming from the same interaction
- ▶ Works well for low momentum particles
 - ▶ 2-5 GeV
- ▶ Implemented in the ALICE TOF detector
 - ▶ Need to achieve 40ps timing resolution

Outline

- ▶ What are the requirements for Detectors at the LHC?
 - ▶ The physics requirements
 - ▶ Coping with the LHC environment
- ▶ Particles passing through matter
- ▶ Tracking Detectors
- ▶ Calorimetry
- ▶ Muon Detection
- ▶ Detectors for triggering/timing/particle ID
- ▶ **Preparing for the future - higher luminosity implications**

Increasing the luminosity of the LHC

- ▶ If the integrated luminosity delivered by the a collider reaches a plateau, then after a few years, it takes a very long time to reduce the statistical error on a measurement by a factor of two
- ▶ If we want to look at channels where we are statistically limited in the information we can extract, or to look for very rare decay channels, then we have to find ways to increase the peak and integrated luminosity of the accelerator
- ▶ This can have very serious implications on the performance and requirements of the detectors



LHC luminosity upgrade: why and when?

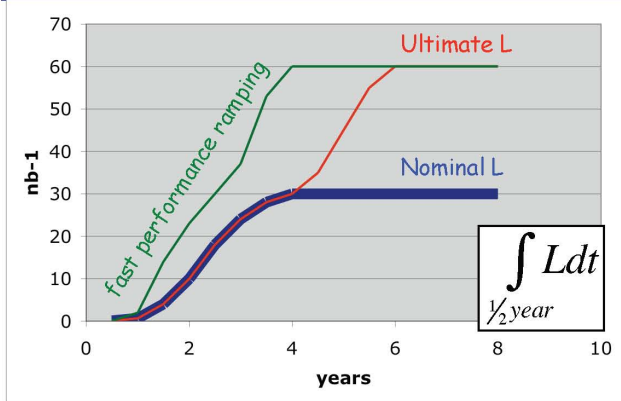

How fast performance is expected to increase:

- ◆ 4 y up to nominal L
- ◆ 4 y up to nominal L & 2 y up to ultimate L
- ◆ 4 y up to ultimate

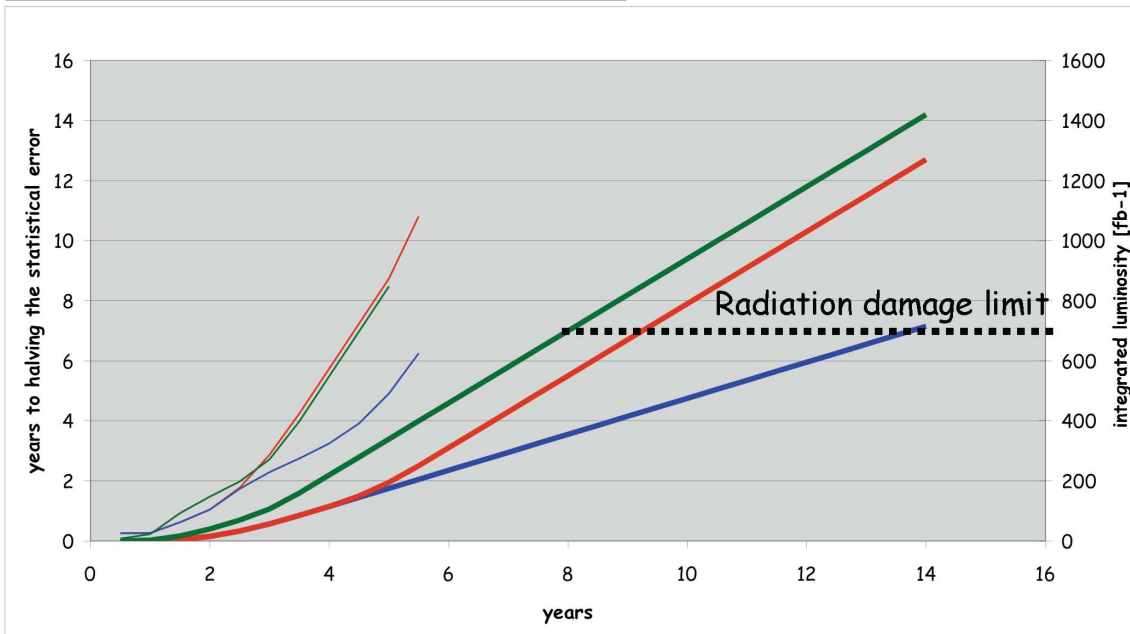

- ◆ IR quadrupole lifetime ≥ 8 years owing to high radiation doses
- ◆ halving time of the statistical error ≥ 5 y already after 4-5 y of operation
- ◆ luminosity upgrade to be planned by the middle of next decade

Some current plans for increasing the luminosity

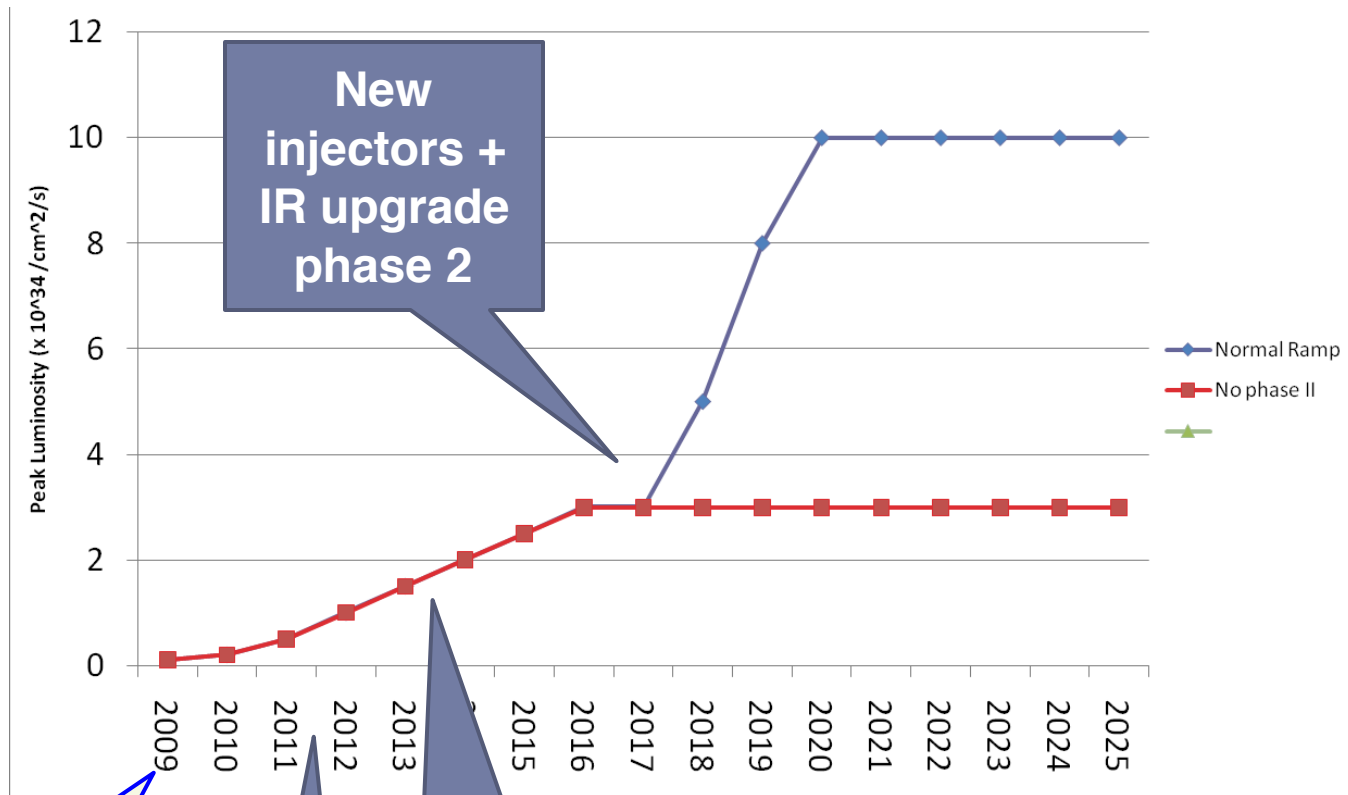

New injectors + IR upgrade phase 2

Early operation

Linac4 + IR upgrade phase 1

Collimation phase 2

Luminosity evolution for potential schemes

- ▶ **It may be possible to reach between 10 and 15 times the peak luminosity of the LHC design**

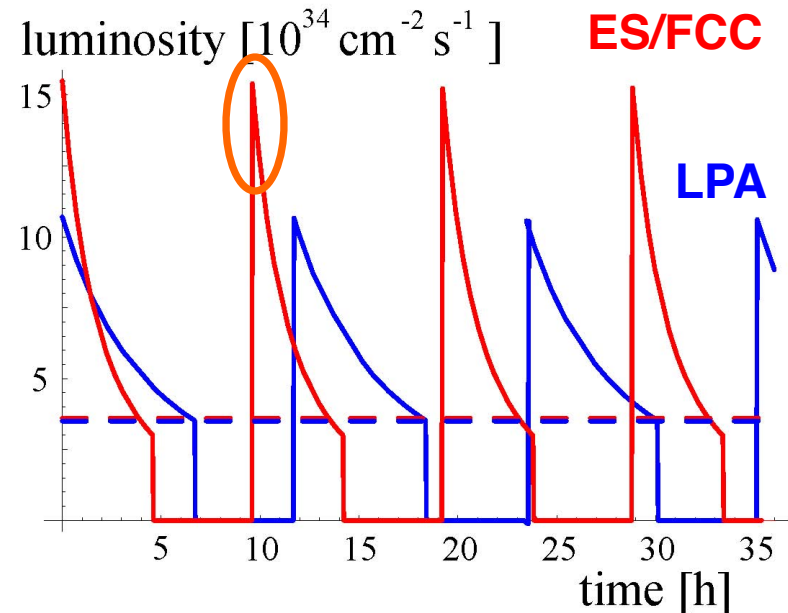
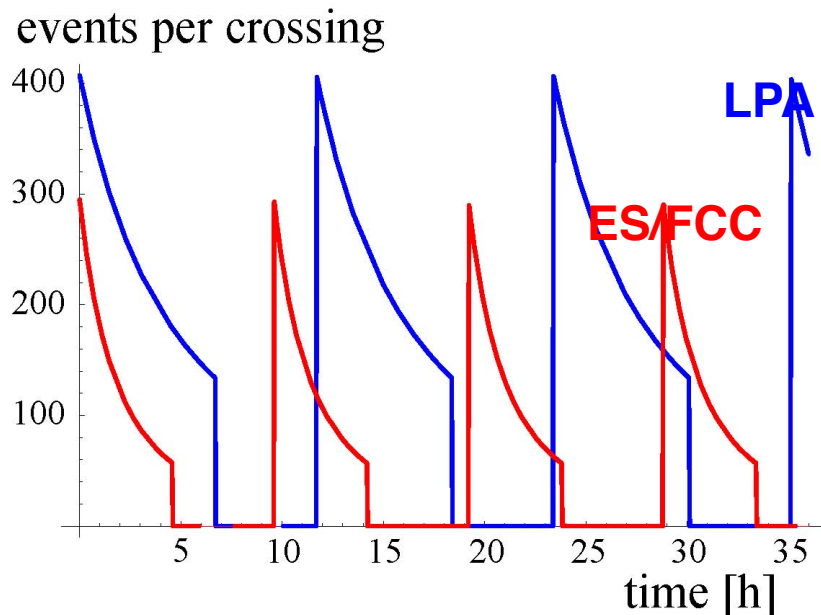

- ◻ **However the number of underlying events in every crossing can become extremely large**

CMS from LHC to SLHC

$10^{32} \text{ cm}^{-2} \text{ s}^{-1}$

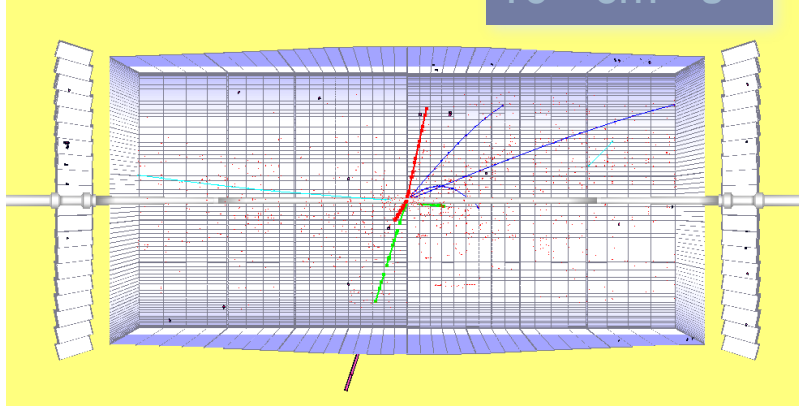

10^{33}

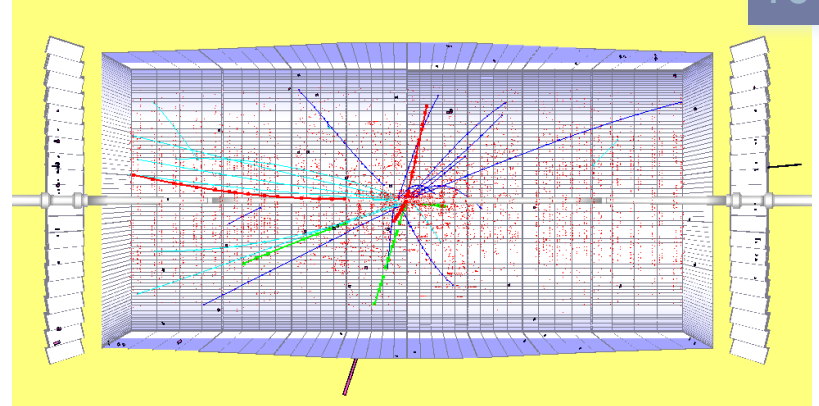

10^{34}

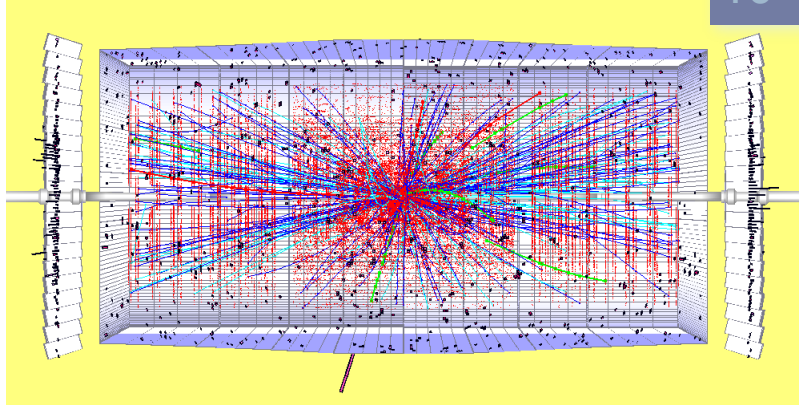

10^{35}

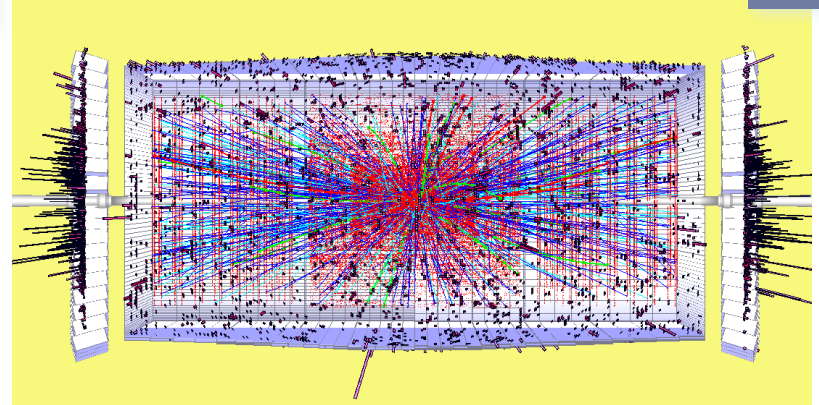

The tracker is the key detector which will require upgrading for SLHC Phase 2

Tracking with 500 min Bias events

- ▶ Study of current CMS tracker for Heavy Ion events
- ▶ Track density very similar to 50ns running
 - ▶ $dn^{ch}/d\eta/\text{crossing} \approx 3000$
 - ▶ Tracker occupancy very high
 - ▶ **Need more pixel layers/shorter strips**
- ▶ Tracking possible
 - ▶ When tracks are found they are well measured
 - ▶ Efficiency and fake rate suffer
 - ▶ CPU Intensive

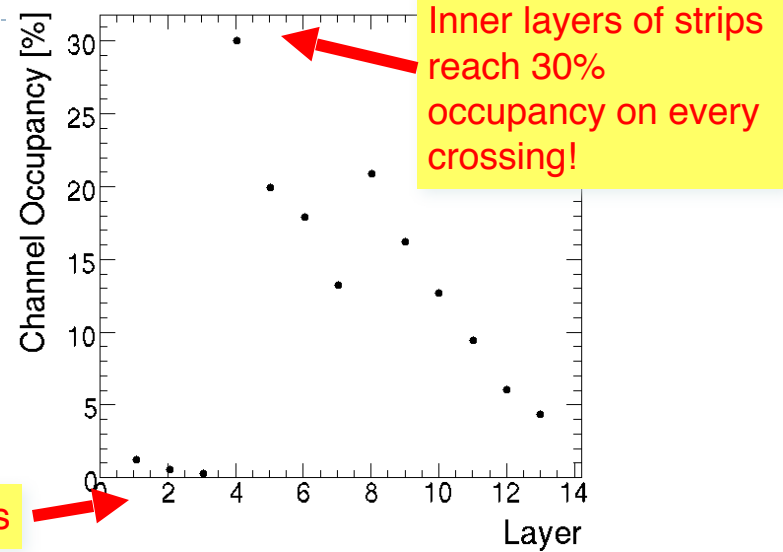

Momentum Resolution

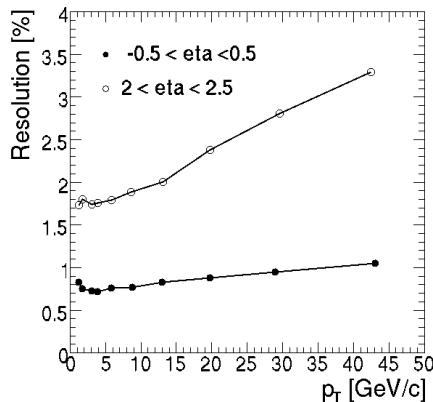

Transverse Impact Parameter Resolution

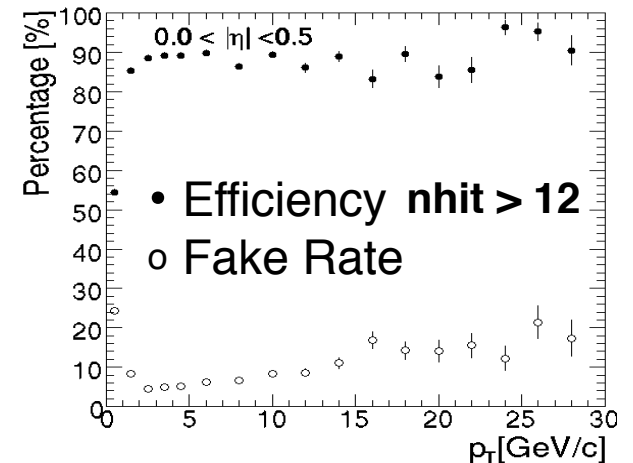
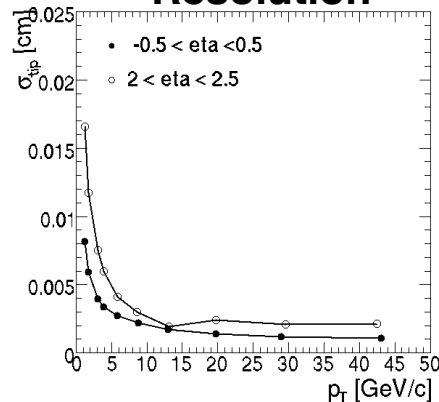

Level 1 Trigger

- ▶ One of the key issues for CMS is the requirement to include some element of tracking in the Level 1 Trigger
 - ▶ There may not be enough rejection power using the muon and calorimeter triggers to handle the higher luminosity conditions at SLHC
- ▶ Adding tracking information at Level 1 gives the ability to adjust P_T thresholds

Level 1 Trigger has no discrimination for $P_T > \sim 20$ GeV/c

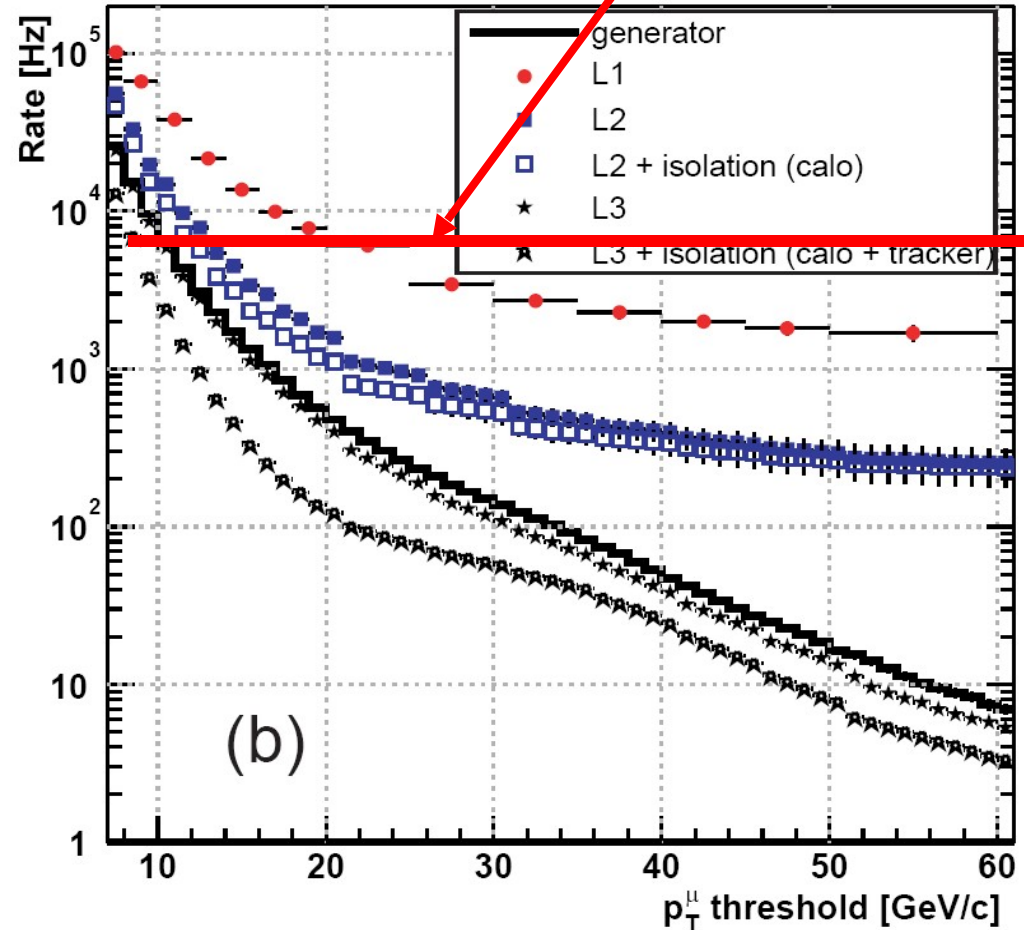

Concepts: Tracking Trigger

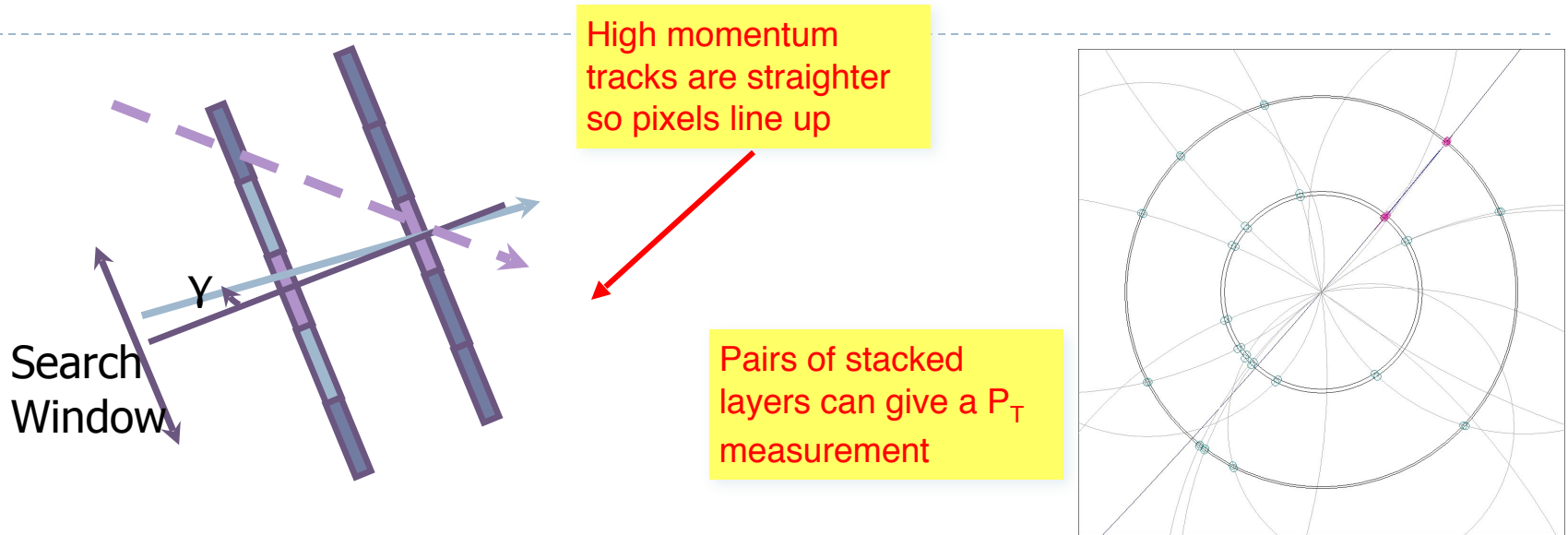

Geometrical p_T -cut - [J. Jones](#), [A. Rose](#), [C. Foudas](#) LECC 2005

- ▶ Why not use the inner tracking devices in the trigger?
 - ▶ Number of hits in tracking devices on each trigger is enormous
 - ▶ Impossible to get all the data out in order to form a trigger inside
 - ▶ How to correlate information internally in order to form segments?
- ▶ Topic requiring substantial R&D
 - ▶ “Stacked” layers which can measure p_T of track segments locally
 - ▶ Two layers about 1mm apart that could communicate

A word on radiation hardness

- ▶ In order to implement complicated features like a tracking trigger, we will have to have more and more sophisticated electronics
- ▶ The electronics industry is making smaller and smaller devices
 - ▶ This is good as we can get more electronics in a smaller area
 - ▶ The electronics uses less power
- ▶ However, the smaller and smaller transistors (45nm now) are more prone to effects of radiation
- ▶ Single Event Upsets (SEU) happen when ionizing particles change the state of a logic bit in a chip
- ▶ We can mitigate against this using strategies like Triple Module Redundancy (TMR)
 - ▶ Build every logic circuit three times on the chip
 - ▶ Compare the results of the outputs
 - ▶ If all three agree, there was no upset
 - ▶ If they don't there has been an upset, take the result of two/three and signal a problem
- ▶ But this adds more complexity to the circuits, ...

Radiation Damage to calorimeters

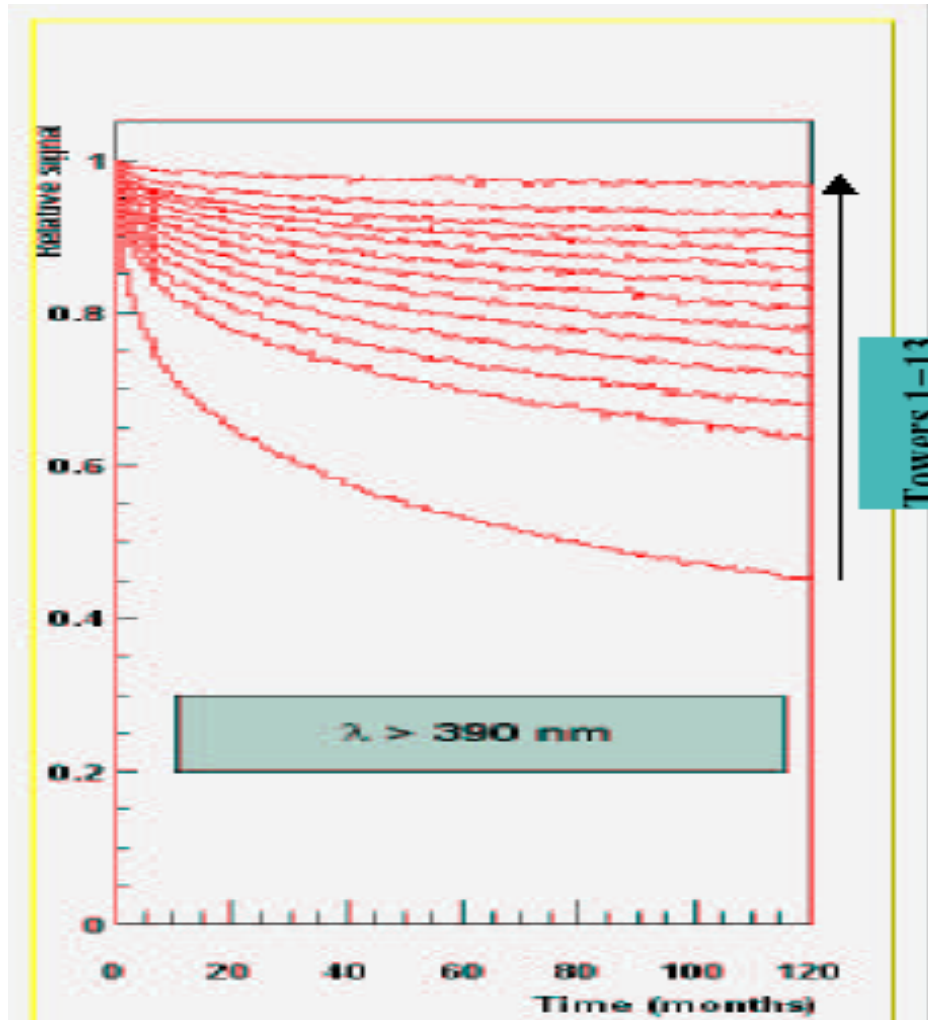

- Tower 1 loses 60% of light during LHC, down to 4% of original after SLHC.
- Tower 2 down to 23% after SLHC.
- SLHC “kills” a few high eta towers.

Andre Gribushin

High Backgrounds rates in the ATLAS Muon detectors

Limitations – occupancies of the chambers

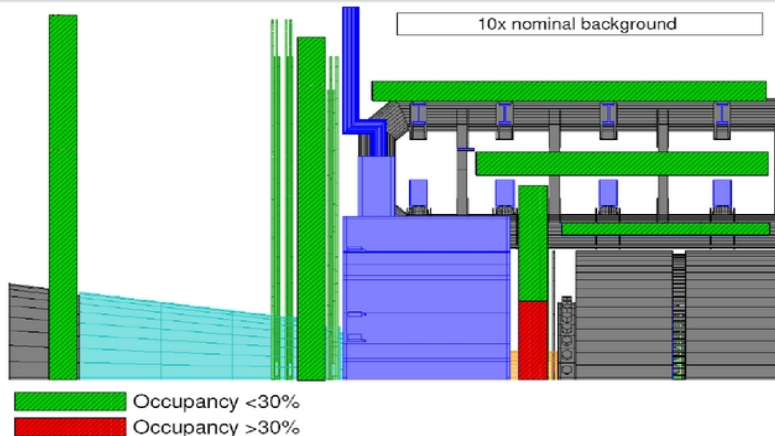

At least half of the chambers in the inner end-cap disk would have to be replaced by chambers with higher high rate capability.

Limitations – occupancies of the chambers

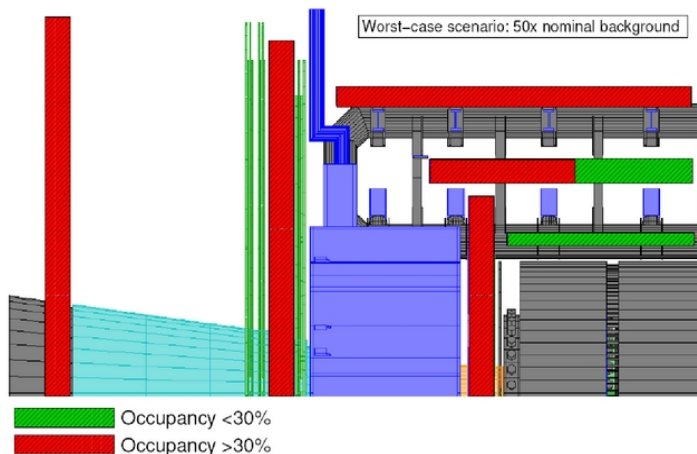

- ▶ Background rates very uncertain (~5x)
 - ▶ Need LHC experience
- ▶ Start before LHC:
 - ▶ Aging studies
 - ▶ Rad hard electronics
 - ▶ Selective readout
 - ▶ High-rate chamber prototypes
- ▶ Use existing chambers as far as possible

Worst case

Almost all chamber would have to be replaced.

ATLAS Forward calorimetry

- ▶ However, FCAL ($|\eta| > 3.1$) particularly subject to beam radiation
- ▶ Simulation of LAr FCAL beam heating (pessimistic case)
- ▶ Maximum temperature 93.8K – enough to boil LAr
- ▶ Uncertainties in heat load, convection could make things better or worse; other endcap calorimeters also implicated
 - Improve FCAL cooling (open endcap cryostat)
 - Big challenge
 - New “warm” FCAL plug?

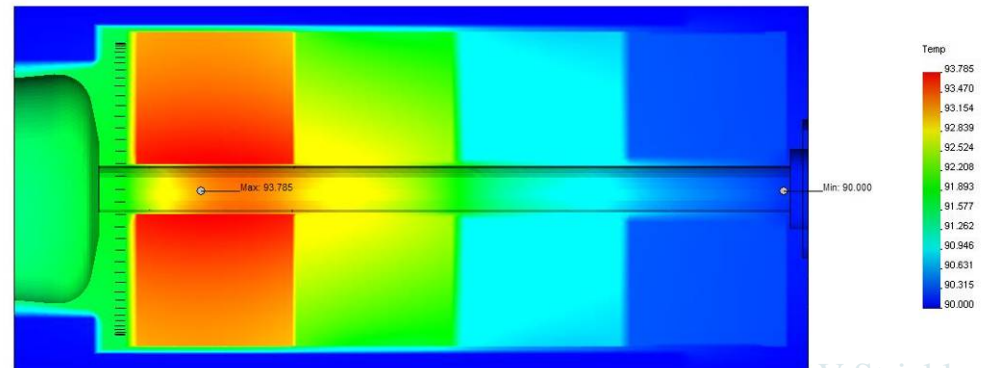
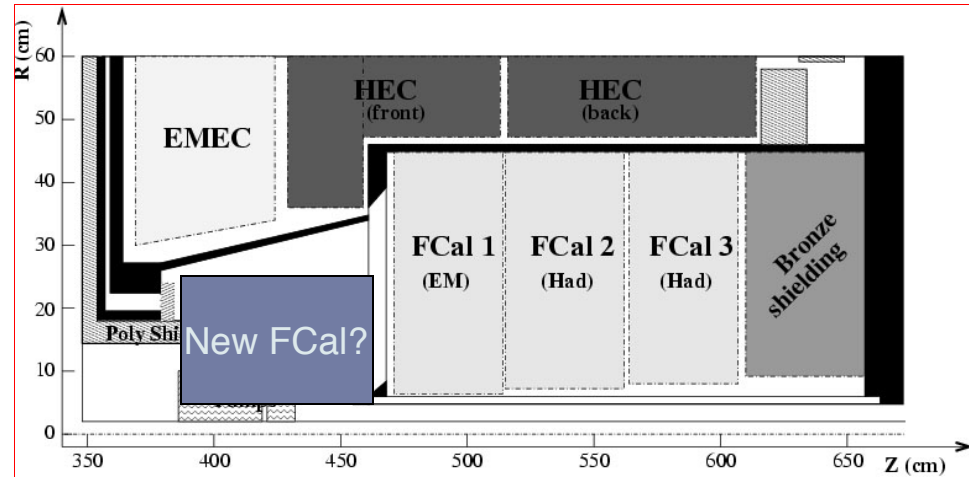

V Strickland

Summary

- ▶ Instrumentation is a vital part of particle physics
 - ▶ Precision measurements and searches for new phenomena require excellent performance and understanding of detectors
- ▶ Very fast overview of detectors
- ▶ Hopefully helpful for you in understanding seminars and journal club
- ▶ More to come next term...